













3202



**2023
PARTS
CATALOG**



**2023 PARTS CATALOG
TABLE OF CONTENTS**

	FILTRATION PARTS	PAGES 2 - 4
	DUCT HOSE, COUPLERS & ACCESSORIES	PAGE 5 - 6
	VACUUM HOSES, COUPLERS & ACCESSORIES	PAGES 7 - 16
	COMPRESSED AIR SYSTEM PARTS	PAGES 17 - 24
	ELECTRICAL SYSTEM PARTS	PAGES 25 - 30
	ENGINE & DRIVE PARTS	PAGES 31 - 42
	WEAR PARTS & WEAR PLATES	PAGES 43 - 48
	HYDRAULIC SYSTEM PARTS	PAGES 48 - 54
	MISCELLANEOUS PARTS	PAGES 54 - 63
	DUST COLLECTOR VACTAGON	PAGES 64 - 67 PAGES 68 - 72

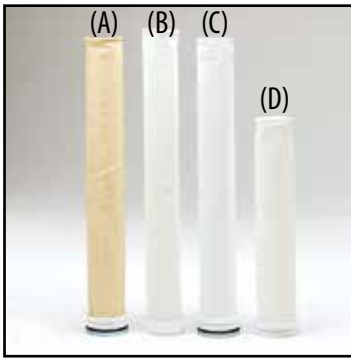

FILTER BAGS

VECLOADER FILTERBAGS

40" COATED FILTERBAGS for Vecloaders

(B) Part No. – FN8001

38" SNAP-IN COATED FILTERBAG w/Ground Wire

Fits: Hurricane HT-500, HT-600, HT-755, HT-828,
HS-500 EM & Quiet Cube

(C) Part No. – FN8013

28" COATED FILTERBAGS for Vecloaders

(D) Part No. – FN8002

VECTOR SNAP-IN COATED FILTERBAG, 40"

Part No. – FN7100

HURRICANE FILTERBAGS

38" SNAP-IN COATED FILTERBAGS

(STANDARD BAGS)

Fits: Hurricane HT-500, HT-600, HT-755,
HT-828, HS-500 EM, HS-800 EM & Quiet Cube

Part No. – FN8014

38" SNAP-IN COATED NOMEX FILTERBAG

w/Ground Wire

Fits: Hurricane HT-500, HT-600, HT-755, HT-828,
HS-500 EM & HS-800 EM

(A) Part No. – FN8013N

38" SNAP-IN COATED FILTERBAG

w/Nomex High Temp Filter Media

Fits: Hurricane HT-500, HT-600, HT-755, HT-
828, HS-500 EM, HS-800 EM & Quiet Cube

Part No. – FN8014-N

28" SNAP-IN COATED FILTERBAG

Fits: Hurricane HT-400, HT-500 (with 28" bags),
HT-300 (with reverse pulse filter bags)

Part No. – FN8019

28" SNAP-IN COATED FILTERBAG

w/Ground Wire

Fits: Hurricane HT-500

Part No. – FN8023



GUZZLER BAGS

GUZZLER FILTERBAG

4-5/8" Dia. x 70" L – Raw-Edge Top,
Single Polypropylene Felt

Part No. – FN5000

GUZZLER FILTERBAG

4-5/8" Dia. x 70" L – Coated Guzzler Filterbag

Part No. – FN5001

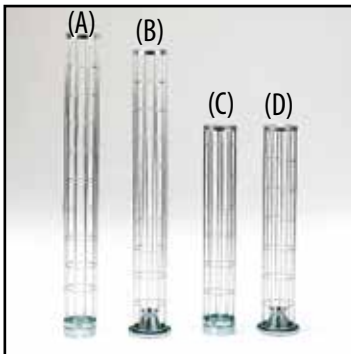

CAGES

40" CAGES for Vecloaders

(A) Part No. – FN8003

38" CAGES w/Venturi for Hurricane

Fits: Hurricane HT-400, HT-500, HT-600, HT-755,
HT-828, HS-500 EM, HS-800 EM & Quiet Cube

(B) Part No. – FN8065

38" STAINLESS STEEL CAGE for Hurricane

Fits: Hurricane HT-500, HT-600, HT-755, HT-828,
HS-500 EM & HS-800 EM

Part No. – FN8065-S

28" CAGES for Vecloaders

(C) Part No. – FN8004

28" STEEL CAGES w/Venturi

Fits: Hurricane HT-300, HT-400, HS-400 & HT-500

(D) Part No. – FN8018



(A)



(B)

SHAKER BAG – for Hurricane 300

(A) Part No. – FN9261

CLAMPS for Filterbags

Fits: Vecloader

(B) Part No. – FN9876



FILTRATION PARTS



DUST COLLECTOR FILTER CARTRIDGE – 6.25" OD x 36.4" L

Fits: ECS & Vector Dust Collectors

Part No. – FN0217

TOP LOAD FILTER CARTRIDGE – Primary, 5" OD x 28" L – Pleated

Part No. – FN0227

TOP LOAD FILTER CARTRIDGE – 5" OD x 38" L – Pleated (Shown)

Fits: Hurricane 828

Part No. – FN0261

VERTICAL DUST COLLECTOR CARTRIDGE FILTER – 5.5" X 36"

Fits: IVEC Electric 12,000 cfm Dust Collectors with Vertical Filters

Part No. – FN11054



DUST COLLECTOR FILTER CARTRIDGE – 5.5" OD x 36" L

Fits: ECS Collector

Part No. – FN2534



HEPA FILTER – 24" x 24" x 12" Vacuum Rated

Fits: Vecloader

Part No. – FN8005



BLOWER SAFETY FILTER for Hurricanes (Shown)

Part No. – FN8006H

BLOWER SAFETY FILTER for Vecloaders

Part No. – FN8006

BLOWER SAFETY – Hurricane 755/828

17.6" OD x 34" H

Part No. – FN8058

HEPA FILTER – for Older Vecloaders – 12.75" OD x 22" H

Part No. – FN8052



ALUMINUM AIR HORNS – Vecloader Baghouse

Fits: Vecloader

Part No. – FN1032

HEPA FILTER – for Hurricanes & Vecloader

12.75" OD x 32" H

Part No. – FN8055-1

VECLOADER

BLOWER SAFETY FILTER CARTRIDGE

12.75" OD x 36" L – Open/Closed w/Bolt Hole

Part No. – FN0285

BLOWER SAFETY FILTER

for Hurricane 300

Part No. – FN0035



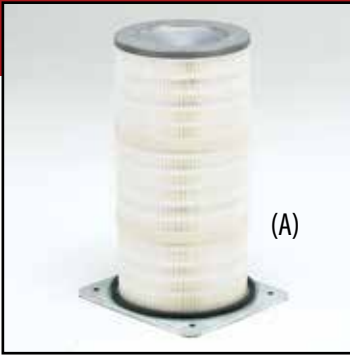

26" ENTECH FILTERS for 6000 CFM DUST COLLECTOR

(A) Part No. – FN2492

30" ENTECH FILTERS for 6, 12, 20, 30 & 40,000 CFM Dust Collectors

Part No. – FN2493

30" ENTECH HEPA FILTER

Part No. – FN2493H

IPEC FILTER –12.75" OD x 26" L – Open/Closed

Part No. – FN2494



IVEC ELECTRIC DUST COLLECTOR FILTER SIDE LOAD

Fits: DC-6,000, DC-12,000 & DC-20,000

Part No. – FN3777

IVEC HIGH TEMP FILTER w/Moisture Resistant Media (SBHO) Good to 275 Degrees, for IVEC Dust Collectors

Part No. – FN3777-SBHO

IVEC HEPA FILTER for Electric Dust Collector

12.75" OD x 26" L – Open/Open

Part No. – FN3777-H

IPEC FILTER –12.75" OD x 26" L Open/Open

Part No. – FN2495

VACUUM FILTER –12.75" OD x 26" L

Open/Open

Eliminator & Stellon

Part No. – FN2532

36" ENTECH FILTERS

Part No. – FN2578

IVEC DIESEL DUST COLLECTOR FILTER for 6, 12, 20, 30, 45,000 CFM Dust Collectors

Part No. – FN7546

IVEC HEPA DIESEL DUST COLLECTOR FILTER

can be used in place of FN7546

Part No. – FN7546H

DUST COLLECTOR FILTER – Ingersoll Rand,

13.9" x 27" L – Open/Open

Part No. – FN1667

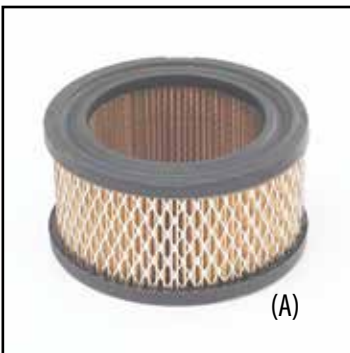

AIR FILTER for Ingersoll Rand Air Compressor

Fits: Vecloader

(A) Part No. – FN8007



AIR FILTER HOUSING for Pneumatic Dump Valve Option

(B) Part No. – FN8008

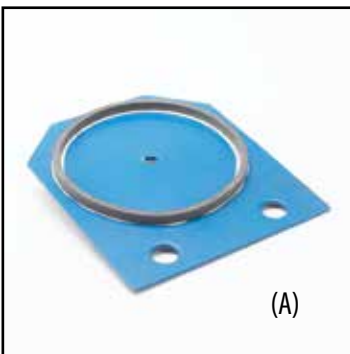

FILTER HOLD DOWN PLATE for IVEC Dust Collectors

(A) Part No. – FN3778



1/2" HANDLE NUT for IVEC Electric Dust Collectors

(B) Part No. – FN3779

GASKET for Filter Hold-down Plate

Part No. – FN3780



1/8" INLINE FILTER for Magnehelic Gauge

Fits: Vecloader

(A) Part No. – FN8011



MAGNEHELIC GAUGE 0-10" of Water

Fits: Hurricane, Dust Collectors & Vecloader

(B) Part No. – FN8009

MAGNEHELIC GAUGE 0-50" of Water

Fits: Hurricane & Vecloader

Part No. – FN8010

MAGNEHELIC GAUGE MOUNTING PLATE

Part No. – FAB7575



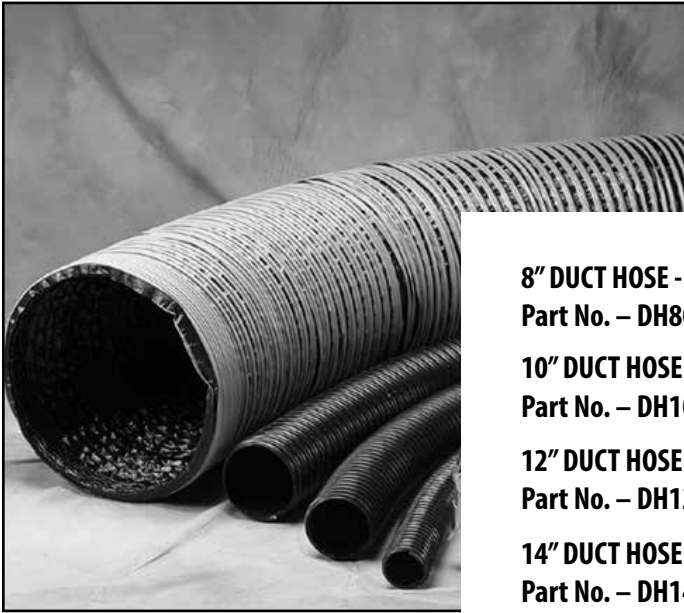

8" DUCT HOSE - 25 ft Sections
Part No. – DH8000

10" DUCT HOSE - 25 ft Sections
Part No. – DH1000

12" DUCT HOSE - 25 ft Sections
Part No. – DH1200

14" DUCT HOSE - 25 ft Sections
Part No. – DH1400

16" HEAVY DUTY BRIDGE HOSE
w/Wear Strip (TH1699HD) 25 ft Sections
Part No. – DH1600

18" HEAVY DUTY BRIDGE HOSE
w/Wear Strip (TH 1899-HD) 25 ft Sections
Part No. – DH1800

20" HEAVY DUTY BRIDGE HOSE
w/Wear Strip (TH 1899-HD) 25 ft Sections
Part No. – DH2000

24" HEAVY DUTY BRIDGE HOSE
w/Wear Strip (TH 1899-HD) 25 ft Sections
Part No. – DH2400



6" BRIDGE CLAMP for 6" Duct Hose
Part No. – DH6003

8" BRIDGE CLAMP for 8" Duct Hose
Part No. – DH8003

10" BRIDGE CLAMP for 10" Duct Hose
Part No. – DH1003

12" BRIDGE CLAMP for 12" Duct Hose
Part No. – DH1203

16" BRIDGE CLAMP for 16" Duct Hose
Part No. – DH1603

18" BRIDGE CLAMP for 18" Duct Hose
Part No. – DH1803

20" BRIDGE CLAMP for 20" Duct Hose
Part No. – DH2003

24" BRIDGE CLAMP for 24" Duct Hose
Part No. – DH2400-1

(Bridge Clamps available in all sizes)





Coupled hose shown with Hose Adapter and QF Clamp



- 12" INLET SCREEN**
Part No. – DH1204
- 16" INLET SCREEN**
Part No. – DH1604
- 18" INLET SCREEN**
Part No. – DH1804
- 20" INLET SCREEN**
Part No. – DH2004
- 24" INLET SCREEN**
Part No. – DH2404



- 12" ALUMINUM DUCT CONNECTORS**
for Connecting 2-12" Duct Hoses
Part No. – DH1202
- 16" ALUMINUM DUCT CONNECTORS**
for Connecting 2-16" Duct Hoses
Part No. – DH1602
- 18" ALUMINUM DUCT CONNECTORS**
for Connecting 2-18" Duct Hoses
Part No. – DH1802
- 20" ALUMINUM DUCT CONNECTORS**
for Connecting 2-20" Duct Hoses
Part No. – DH2002
- 24" ALUMINUM DUCT CONNECTORS**
for Connecting 2-24" Duct Hoses
Part No. – DH2402

(Connectors available in all sizes)



- 6" QF HOSE ADAPTER**
Part No. – DCP3282-06
- 8" QF HOSE ADAPTER**
Part No. – DCP3282-08
- 10" QF HOSE ADAPTER**
Part No. – DCP3282-10
- 12" QF HOSE ADAPTER**
Part No. – DCP3282-12
- 16" QF HOSE ADAPTER 5.5" 20GA GALV**
Part No. – DCP3282-16
- 20" QF HOSE ADAPTER 5.5" 20GA GALV**
Part No. – DCP3282-20



- | | |
|--|--|
| 6" QF CLAMP
Part No. – DCP3260-06 | 12" QF CLAMP 22GA GALV
Part No. – DCP3260-12 |
| 8" QF CLAMP
Part No. – DCP3260-08 | 16" QF CLAMP 20GA GALV
Part No. – DCP3260-16 |
| 10" QF CLAMP AND PIN
Part No. – DCP3260-10 | 20" QF CLAMP 20GA GALV
Part No. – DCP3260-20 |



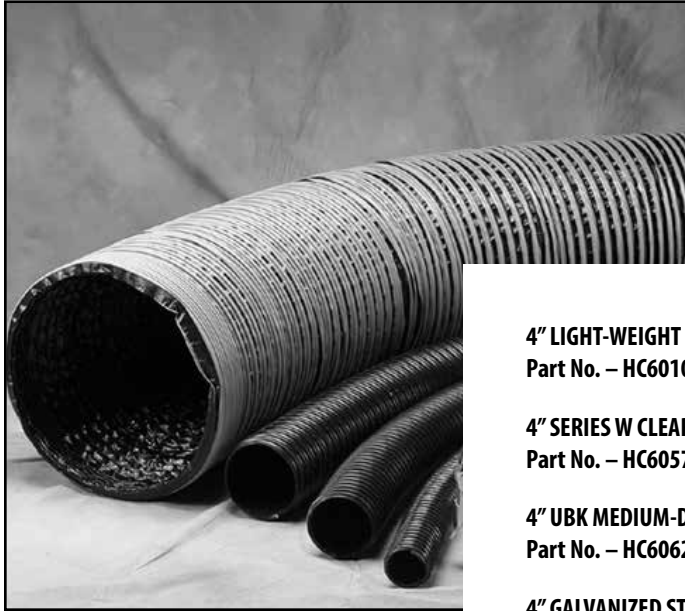

All prices are per foot unless noted as otherwise.
All hoses available in 50 foot or 100 foot lengths.

2" TIGER TR1 MEDIUM-DUTY RUBBER HOSE
Part No. – HC2200

2" UREFLEX 1 HEAVY-DUTY VACUUM HOSE
Part No. – HC2000

3" UREFLEX 1 HEAVY-DUTY RUBBER HOSE
Part No. – HC3000

3" SERIES W CLEAR MEDIUM-DUTY HOSE
Part No. – HC3000W

3" TIGER TR1 MEDIUM-DUTY RUBBER HOSE
Part No. – HC3300

3" UBK MEDIUM-DUTY RUBBER HOSE
Part No. – HC6119

4" TIGER TR1 MEDIUM-DUTY RUBBER HOSE
Part No. – HC4400

4" KANAFLEX 180HR HIGH TEMP HOSE
Part No. – HC6009H

4" LIGHT-WEIGHT RUBBER HOSE (180 BL)
Part No. – HC6010

4" SERIES W CLEAR MEDIUM-DUTY HOSE
Part No. – HC6057

4" UBK MEDIUM-DUTY HOSE
Part No. – HC6062

4" GALVANIZED STEEL INTERLOCKED HOSE
Part No. – HC6069

4" UREFLEX 1 HEAVY-DUTY RUBBER HOSE
Part No. – HC6009

4" UREFLEX 2 HEAVY-DUTY RUBBER HOSE
Part No. – HC6124

4" TIGERFLEX SERIES WT HOSE
Part No. – HC6802

5" TIGER TR1 MEDIUM-DUTY RUBBER HOSE
Part No. – HC5500

5" UREFLEX 1 HEAVY-DUTY RUBBER HOSE
Part No. – HC6011

5" LIGHT-WEIGHT RUBBER HOSE – Whip Line
Part No. – HC6012

5" UREFLEX 2 HEAVY-DUTY RUBBER HOSE
Part No. – HC6013

5" SERIES W CLEAR MEDIUM-DUTY HOSE
Part No. – HC6055

6" UREFLEX 1 HEAVY-DUTY RUBBER HOSE
Part No. – HC6025

6" UREFLEX 2 HEAVY-DUTY RUBBER HOSE
Part No. – HC6025-2

6" x 16' HOPPER CONNECTION HOSE
Part No. – HC6024

6" x 13.5' HOPPER CONNECTION HOSE
Part No. – HC6024-13.5

6" KANAFLEX 180HR HIGH TEMP HOSE
Part No. – HC6025H

6" STAINLESS STEEL HOSE
Part No. – HC6056

6" UBK MEDIUM-DUTY RUBBER HOSE
Part No. – HC6063

6" LIGHT WEIGHT 180BL HOSE
Part No. – HC6064

6" GALVANIZED STEEL INTERLOCKED HOSE
Part No. – HC6067

6" SERIES W CLEAR MEDIUM-DUTY HOSE
Part No. – HC6090

6" TIGER TR1 MEDIUM-DUTY RUBBER HOSE
Part No. – HC6600

7" HEAVY-DUTY RUBBER HOSE (180AR)
Part No. – HC7000

8" x 15' HOPPER CONNECTION HOSE
Part No. – HC6041

8" UREFLEX 1 HEAVY-DUTY RUBBER HOSE
Part No. – HC6042

8" SERIES W HOSE
Part No. – HC6058

8" TIGERFLEX SERIES WT HOSE
Part No. – HC6800





- 2.5" POWER LOCK HOSE CLAMP**
Part No. – HC3100
- 3" POWER LOCK HOSE CLAMP**
Part No. – HC3030
- 4" POWER LOCK HOSE CLAMP**
Part No. – HC6021
- 5" POWER LOCK HOSE CLAMP**
Part No. – HC6022

- 6" POWER LOCK HOSE CLAMP**
Part No. – HC6023
- 8" POWER LOCK HOSE CLAMP**
Part No. – HC6004



- 2" SPIRAL BOLT HOSE CLAMP**
Part No. – HCSDBC2
- 2.5" SPIRAL BOLT HOSE CLAMP**
Part No. – HCSDBC2.5
- 3" SPIRAL BOLT HOSE CLAMP**
Part No. – HCSDBC3
- 4" SPIRAL BOLT HOSE CLAMP**
Part No. – HCSDBC4

- 5" SPIRAL BOLT HOSE CLAMP**
Part No. – HCSDBC5
- 6" SPIRAL BOLT HOSE CLAMP**
Part No. – HCSDBC6
- 8" SPIRAL BOLT HOSE CLAMP**
Part No. – HCSDBC8
- 10" SPIRAL BOLT HOSE CLAMP**
Part No. – HCSDBC10



- 3" WORM CLAMP**
Part No. – HC6200
- 4" WORM CLAMP**
Part No. – HC6201
- 5" WORM CLAMP**
Part No. – HC6202
- 6" WORM CLAMP**
Part No. – HC6203

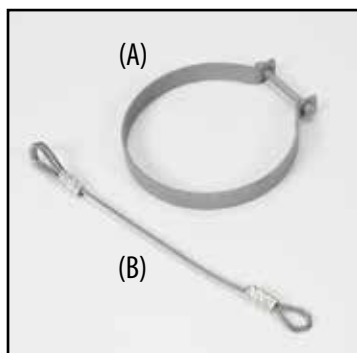

- 6" HOPPER HOSE SUPPORT CLAMP**
(A) Part No. – HC6024-1
- HOPPER HOSE SUPPORT CABLE**
(B) Part No. – HC6024-2





RING LOCKS
Fits: All

- 4" RING LOCK Female Coupler (A) Part No. – HCRL4000**
- 4" RING LOCK Male Coupler (B) Part No. – HCRL4001**
- 4" RING LOCK Clamp (C) Part No. – HCRL4002**
- 4" RING LOCK Gasket Part No. – HCRL4003**
- 4" RING LOCK Clamp w/Handle Part No. – HCRL4004**
- 4" RING LOCK Female/Female Part No. – HCRL4005**
- 5" RING LOCK Female Coupler (A) Part No. – HCRL5000**

- 5" RING LOCK Male Coupler (B) Part No. – HCRL5001**
- 5" RING LOCK Clamp (C) Part No. – HCRL5002**
- 5" RING LOCK Clamp w/Handle Part No. – HCRL5003**
- 5" RING LOCK Gasket Part No. – HCRL5004**
- 6" RING LOCK Female Coupler (A) Part No. – HCRL6000**
- 6" RING LOCK Male Coupler (B) Part No. – HCRL6001**
- 6" RING LOCK Clamp (C) Part No. – HCRL6003**

- 6" RING LOCK Clamp w/Handle Part No. – HCRL6004**
- 6" RING LOCK Gasket Part No. – HCRL6005**
- 8" RING LOCK Female Coupler (A) Part No. – HCRL8000**
- 8" RING LOCK Male Coupler (B) Part No. – HCRL8001**
- 8" RING LOCK Clamp (C) Part No. – HCRL8002**
- 8" RING LOCK Clamp w/Handle Part No. – HCRL8003**
- 8" RING LOCK Gasket Part No. – HCRL8004**
- 8" RING LOCK Male x 6" Female Part No. – HCRL8005**



- 4" FEMALE QUICK COUPLER w/Cap and Chain Part No. – HC6001-1**
- 4" MALE CAP OR PLUG Part No. – HC6001-2**

- 5" FEMALE QUICK COUPLER w/Cap and Chain Part No. – HC6006-1**
- 5" MALE CAP OR PLUG Part No. – HC6088**

- 6" FEMALE QUICK COUPLER w/Cap and Chain Part No. – HC6002-1**
- 6" MALE CAP OR PLUG Part No. – HC6003-1**



- 6" INLET PIPE W/2.5" COUPLING AND CAP AND WATER INLETS Part No. – HC6921**



- 6" INLET ADAPTER 6" x 6" with 2.5" Nipple for Asbestos Vacuums to Connect 2.5" Hose at the Inlet Part No. – HC6059**





STEEL REDUCERS w/Q.D.

Fits: All

4" x 3" STEEL REDUCER

with 3" Female Q.D.

Part No. – HC6115-1

6" x 4" STEEL REDUCER

with 4" Female Q.D.

Part No. – HC6400-1

6" x 5" STEEL REDUCER

with 5" Female Q.D.

Part No. – HC6033-1

8" x 6" STEEL REDUCER

with 6" Female Q.D.

Part No. – HC6080-1



STEEL REDUCERS

Fits: All

3" x 2" STEEL REDUCER

Part No. – HC4102

4" x 2" STEEL REDUCER

Part No. – HC4100

4" x 3" STEEL REDUCER

Part No. – HC6115

5" x 2.5" STEEL REDUCER

Part No. – HC6901

5" x 3" STEEL REDUCER

Part No. – HC6039

5" x 4" STEEL REDUCER

Part No. – HC6038

6" x 3" STEEL REDUCER

Part No. – HC0603

6" x 4" STEEL REDUCER

Part No. – HC6400

6" x 5" STEEL REDUCER

Part No. – HC6033

7" x 6" STEEL REDUCER

Part No. – HC5997

8" x 4" STEEL REDUCER

Part No. – HC6046

8" x 6" STEEL REDUCER

Part No. – HC6080



6" PVC to 6" HOSE CONNECTOR

Part No. – HC6066

5" PVC to 5" HOSE CONNECTOR

Part No. – HC6082



(A)



(B)

6" x 4" REDUCER with a Removable 4" Sleeve

(A) Part No. – HC6402

6" x 5" REDUCER with a Removable 5" Sleeve

(A) Part No. – HC6033-3

8" MALE RING LOCK x

6" FEMALE Q.D. REDUCER

(B) Part No. – HC6065



VACUUM HOSES & ACCESSORIES



- 2" ALUMINUM FLOOR NOZZLE w/Handle**
Part No. – HC1405
- 3" ALUMINUM FLOOR NOZZLE w/Handle**
Part No. – HC1406
- 4" ALUMINUM FLOOR NOZZLE w/Handle**
Part No. – HC1407

Note: Camlock can be permanently welded on hose end. Contact us for pricing.



- 2" ALUMINUM BULK NOZZLE**
Part No. – HC2070-2
- 2.5" ALUMINUM BULK NOZZLE**
Part No. – HC2070-2.5
- 3" ALUMINUM BULK NOZZLE**
Part No. – HC2070-3
- 4" ALUMINUM BULK NOZZLE**
Part No. – HC2070
- 5" ALUMINUM BULK NOZZLE**
Part No. – HC2070-5
- 6" ALUMINUM BULK NOZZLE**
Part No. – HC2070-6

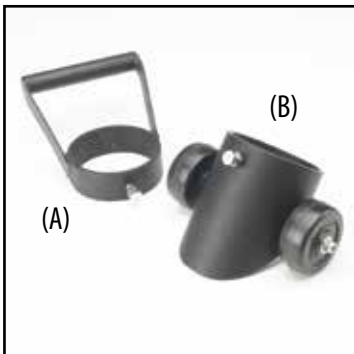

- (A) EXTRA HANDLE for BULK NOZZLE**
 - 2" Part No. – HC2080-2
 - 2.5" Part No. – HC2080-2.5
 - 3" Part No. – HC2080-3
 - 4" Part No. – HC2080-4
 - 5" Part No. – HC2080-5
 - 6" Part No. – HC2080-6
- (B) WHEELS for BULK NOZZLE**
 - 2" Part No. – HC2081-2
 - 2.5" Part No. – HC2081-2.5
 - 3" Part No. – HC2081-3
 - 4" Part No. – HC2081-4
 - 5" Part No. – HC2081-5
 - 6" Part No. – HC2081-6



4" ALUMINUM VACUUM HEAD
Part No. – HC1400



ALUMINUM BLEEDER NOZZLE WITH HANDLE
2" NOZZLE – Part No. – HC2064
3" NOZZLE – Part No. – HC2065
4" NOZZLE – Part No. – HC2066



CART HANDLE 3", 4", 5" & 6"
Part No. – HC6018-1





ROOF/FLOOR NOZZLE (Handle sold separately)

3" NOZZLE – Part No. – HC6019-3

4" NOZZLE – Part No. – HC6019

5" NOZZLE – Part No. – HC6018

6" NOZZLE – Part No. – HC6051



5" WET WASH VACUUM HEAD – Steel

Part No. – HC6018W

Note: Requires 9 to 11 GPM and 3000 PSI to work properly

SPRAY NOZZLES FOR WET HEAD (7 needed)

Part No. – HC0222

MESH SPRAY SCREEN for HC0222

Part No. – HC0222-1

3/4" FEMALE NPT X 3/4" MALE NPT SS EXPANDER

Part No. - HC0225-1

12R16-12MP-12MP-36"

Part No. – HC0225-2



4" ROCK SCOOP for Ballast/Big Rock (Shown w/handle sold separately)

Part No. – HC6026-4

5" ROCK SCOOP for Ballast/Big Rock (Shown w/handle sold separately)

Part No. – HC6026

6" ROCK SCOOP for Ballast/Big Rock (Shown w/handle sold separately)

Part No. – HC6026-3



4", 5" OR 6" ROCK SCOOP Cart Handle

Part No. – HC6026-1



ROOF NOZZLE WHEELS

Part No. – MC7034



ROCK SCOOP WHEELS

Part No. – MC7034-R



VACUUM HOSES & ACCESSORIES



STEEL WYE(S)

Fits: ALL

2" X 1.5" X 1.5" STEEL WYE

Part No. – HC6128

3" x 2" x 2" H.D. STEEL WYE

Part No. – HC6127

3" x 3" x 3" STEEL WYE

Part No. – HC6123

4" x 2" x 2" STEEL WYE

Part No. – HC5999

4" x 2.5" x 2.5" STEEL WYE

Part No. – HC6028

4" x 3" x 3" H.D. STEEL WYE

Part No. – HC8020

4" x 4" x 4" STEEL WYE

Part No. – HC6027

5" x 2" x 2" x 2" STEEL WYE

Part No. – HC5998

5" x 2.5" x 2.5" STEEL WYE

Part No. – HC7101

5" x 3" x 3" STEEL WYE

Part No. – HC7105

5" x 4" x 4" STEEL WYE

Part No. – HC5990

5" x 5" x 5" STEEL WYE

Part No. – HC6087

6" x 3" x 3" STEEL WYE

Part No. – HC6109

6" x 4" x 4" H.D. STEEL WYE

Part No. – HC6121H

6" x 5" x 5" H.D. STEEL WYE

Part No. – HC6118

6" x 6" x 6" STEEL WYE

Part No. – HC6113

8" x 4" x 4" STEEL WYE

Part No. – HC7102

8" x 4" x 4" x 4" STEEL WYE

3 - Way

Part No. – HC7103

8" x 6" x 6" STEEL WYE

Part No. – HC7104



4-WAY SPLITTER – 6" Hose to (4) 2" Hoses

Part No. – HC2067

4-WAY SPLITTER – 5" Hose to (4) 2" Hoses

Part No. – HC2068

4-WAY SPLITTER – 5" Hose to (4) 2.5" Hoses

Part No. – HC2069

IVEC can manufacture almost any size splitter you need. Please call for pricing.



COUPLERS

Fits: All

3" STEEL QUICK DISCONNECT COUPLER, Female

(A) Part No. – HC3334

3" STEEL QUICK DISCONNECT COUPLER, Male

(B) Part No. – HC3333

3" FLAT O-RING FOR QUICK DISCONNECT, Male

(C) Part No. – HC3335-F

4" STEEL QUICK DISCONNECT COUPLER, Female

(A) Part No. – HC6001

4" STEEL QUICK DISCONNECT COUPLER, Male

(B) Part No. – HC6000

4" FLAT O-RING FOR QUICK DISCONNECT, Male

(C) Part No. – HC6036-F

5" STEEL QUICK DISCONNECT COUPLER, Female

(A) Part No. – HC6006

5" STEEL QUICK DISCONNECT COUPLER, Male

(B) Part No. – HC6007

5" FLAT O-RING FOR QUICK DISCONNECT, Male

(C) Part No. – HC6037-F

6" STEEL QUICK DISCONNECT COUPLER, Female

(A) Part No. – HC6002

6" STEEL QUICK DISCONNECT COUPLER, Male

(B) Part No. – HC6003

6" FLAT O-RING FOR QUICK DISCONNECT, Male

(C) Part No. – HC6035-F

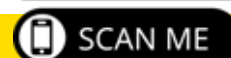



- 1.5" STEEL SLEEVE COUPLING** w/Hose Stop
Part No. – HC6045
- 2" STEEL SLEEVE COUPLING** w/Hose Stop
Part No. – HC6048-1
- 2.5" STEEL SLEEVE COUPLING** w/Hose Stop
Part No. – HC6047
- 3" STEEL SLEEVE COUPLING** w/Hose Stop
Part No. – HC6049-1

- 3.5" STEEL SLEEVE COUPLING** w/Hose Stop
Part No. – HC6048
- 4" STEEL SLEEVE COUPLING** w/Hose Stop
Part No. – HC6050-1
- 5" STEEL SLEEVE COUPLING** w/Hose Stop
Part No. – HC6052-1
- 6" STEEL SLEEVE COUPLING** w/Hose Stop
Part No. – HC6060-1
- 6" x 14" STEEL SLEEVE COUPLING** w/Hose Stop
Part No. – HC6060-2



- 3" SAFETY INLET SLEEVE**
Part No. – HC6049-2
- 4" SAFETY INLET SLEEVE**
Part No. – HC6050-2
- 5" SAFETY INLET SLEEVE**
Part No. – HC6052-3
- 6" SAFETY INLET SLEEVE**
Part No. – HC6060-3



- 3" STEEL SLEEVE COUPLING** for Hose to Hose
Part No. – HC6049
- 4" STEEL SLEEVE COUPLING** for Hose to Hose
Part No. – HC6050
- 5" STEEL SLEEVE COUPLING** for Hose to Hose
Part No. – HC6052

- 6" STEEL SLEEVE COUPLING** for Hose to Hose
Part No. – HC6060
- 8" STEEL SLEEVE COUPLING** for Hose to Hose
Part No. – HC6068



- 4" HIGH RISE HOSE COUPLERS**
Part No. – HC6084
- 5" HIGH RISE HOSE COUPLERS**
Part No. – HC6091
- 6" HIGH RISE HOSE COUPLERS**
Part No. – HC6044



- 6" FEMALE COUPLER** w/3 Clamps
Fits: ALL
Part No. – HC6301



VACUUM HOSES & ACCESSORIES

RUBBER COUPLINGS



For Hose to Hose or PVC to PVC

RUBBER REDUCERS



4" RUBBER COUPLING

Part No. – HC6040

5" RUBBER COUPLING

Part No. – HC6043

6" RUBBER COUPLING

Part No. – HC6121

5" x 4" RUBBER REDUCER

Part No. – HC6720

6" x 5" RUBBER REDUCER

Part No. – HC6722

6" x 4" RUBBER REDUCER

Part No. – HC6719

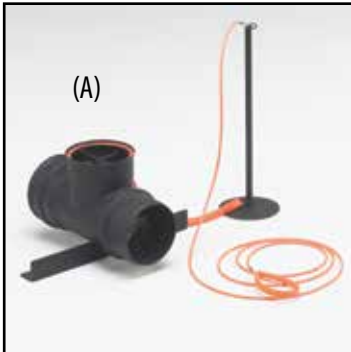

4" INLINE SAFETY RELIEF VALVE

(A) Part No. – HC0002-1

6" INLINE SAFETY RELIEF VALVE

(A) Part No. – HC0002

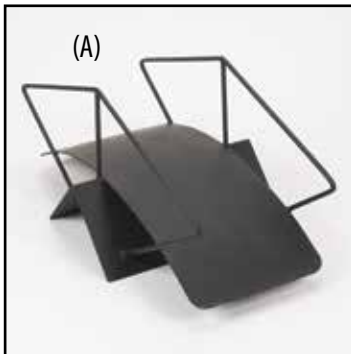

HOSE RADIUS GUARD

(A) Part No. – HC5995

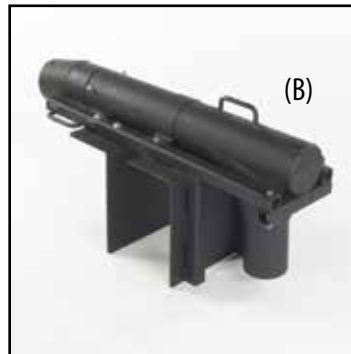

6" ROOF ELBOW w/Frame and Roof Edge Clamp

(B) Part No. – HC5996



4" 45 DEGREE ELBOW – Steel

(A) Part No. – HC6015-1

4" DOUBLE-WEAR ELBOW

(B) Part No. – HC6097



5" 45 DEGREE ELBOW – Steel

(A) Part No. – HC6016-1

6" DOUBLE-WEAR ELBOW

(B) Part No. – HC6098



4" WEAR ELBOW – Steel

Part No. – HC6015

5" WEAR ELBOW – Steel

Part No. – HC6016

6" RE-ENFORCED HEAVY DUTY WEAR ELBOW

Part No. – HC6017-1

8" WEAR ELBOW – Steel

Part No. – HC6017-8



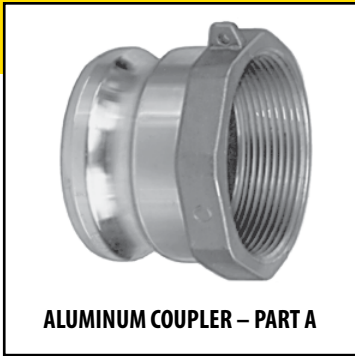

ALUMINUM COUPLER – PART A



ALUMINUM CAMLOCK – PART B

- 2" ALUMINUM COUPLER – Part A**
Part No. – HCALA200
- 3" ALUMINUM COUPLER – Part A**
Part No. – HCALA300
- 4" ALUMINUM COUPLER – Part A**
Part No. – HCALA400
- 6" ALUMINUM COUPLER – Part A**
Part No. – HCALA600
- 8" ALUMINUM COUPLER – Part A**
Part No. – HCALA8

- 2" ALUMINUM CAMLOCK – Part B**
Part No. – HCALB200
- 3" ALUMINUM CAMLOCK – Part B**
Part No. – HCALB300
- 4" ALUMINUM CAMLOCK – Part B**
Part No. – HCALB400
- 6" ALUMINUM CAMLOCK – Part B**
Part No. – HCALB600

All Camlocks-Female w/Male Threads



ALUMINUM COUPLER – PART C

- 2" ALUMINUM COUPLER – Part C**
Part No. – HCALC200
- 2.5" ALUMINUM COUPLER – Part C**
Part No. – HCALC250
- 3" ALUMINUM COUPLER – Part C**
Part No. – HCALC300
- 4" ALUMINUM COUPLER – Part C**
Part No. – HCALC4

- 5" ALUMINUM COUPLER – Part C**
Part No. – HCALC5
- 6" ALUMINUM COUPLER – Part C**
Part No. – HCALC600
- 8" ALUMINUM COUPLER – Part C**
Part No. – HCALC8



ALUMINUM COUPLER – PART D

- 2" ALUMINUM COUPLER – Part D**
Part No. – HCALD200
- 2.5" ALUMINUM COUPLER – Part D**
Part No. – HCALD250
- 3" ALUMINUM COUPLER – Part D**
Part No. – HCALD300
- 4" ALUMINUM COUPLER – Part D**
Part No. – HCALD400
- 6" ALUMINUM COUPLER – Part D**
Part No. – HCALD600



ALUMINUM DUST PLUG – PART DP

- 2" ALUM DUST PLUG – Part DP**
Part No. – HCALDP200
- 2.5" ALUM DUST PLUG – Part DP**
Part No. – HCALDP250
- 3" ALUM DUST PLUG – Part DP**
Part No. – HCALDP300
- 4" ALUM DUST PLUG – Part DP**
Part No. – HCALDP400
- 5" ALUM DUST PLUG – Part DP**
Part No. – HCALDP500
- 6" ALUM DUST PLUG – Part DP**
Part No. – HCALDP600



ALUMINUM COUPLER – PART E

- 2" ALUMINUM COUPLER – Part E**
Part No. – HCALE200
- 2.5" ALUMINUM COUPLER – Part E**
Part No. – HCALE250
- 3" ALUMINUM COUPLER – Part E**
Part No. – HCALE300

- 4" ALUMINUM COUPLER – Part E**
Part No. – HCALE4
- 5" ALUMINUM COUPLER – Part E**
Part No. – HCALES
- 6" ALUMINUM COUPLER – Part E**
Part No. – HCALE600



ALUMINUM CAMLOCK – PART F

- 2" ALUMINUM CAMLOCK**
Male w/ Male Threads Camlock, Part F
Part No. – HCALF200
- 2.5" ALUMINUM CAMLOCK**
Male w/ Male Threads Camlock, Part F
Part No. – HCALF250
- 3" ALUMINUM CAMLOCK**
Male w/ Male Threads Camlock, Part F
Part No. – HCALF300

- 4" ALUMINUM CAMLOCK**
Male w/ Male Threads Camlock, Part F
Part No. – HCALF400
- 6" ALUMINUM CAMLOCK**
Male w/ Male Threads Camlock, Part F
Part No. – HCALF600

ALUMINUM COUPLERS AND CAMLOCKS AVAILABLE IN ALL SIZES FROM 2" TO 8". Call or email for prices.





DIAPHRAGM REBUILD KIT for Baghouse – Old Style, 5 Bolt, Veoloaders / Hurricanes
 Fits: Hurricane HT-500, HT-600, HT-755, HT-828 & Veoloader
Part No. – AR4017



DIAPHRAGM REBUILD KIT for Baghouse – New Style, 4 Bolt w/Brass Tab
 Fits: Hurricane HT-500, HT-600, HT-755, HT-828, HS-500 EM, HS-800 EM & Electric Dust Collectors
Part No. – AR4017-1

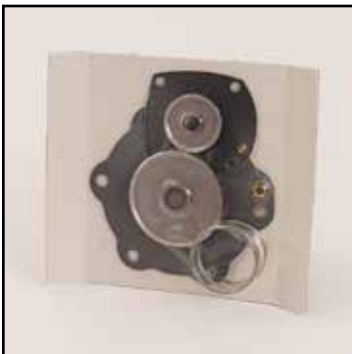

DIAPHRAGM REBUILD KIT For Filter Pulsing on IVEC 20,000 CFM Diesel Dust Collector
Part No. – AR4017-3



**AIROFINER 2
 DESICCANT KIT**
 Old Style Air Dryer w/o Fins
 Fits: Veoloader
Part No. – AR4001



AIR DRYER REBUILD KIT
 for Hurricanes Built 1997-2006,
 Air Dryer w/Vertical Fins
 Fits: Hurricane HT-500, HT-600,
 HT-755 & HT-828
Part No. – AR4002



**ARTIC AIR DRYER
 CARTRIDGES**
Part No. – DCP1001-1



**ARCTIC AIR DRYER
 REBUILD KIT**
 for DCP1001
Part No. – DCP1001-2





AIR DRYER DESICCANT CARTRIDGE w/o Fins, 2008 or Newer Hurricanes
 Fits: Hurricane HT-400, HT-500, HT-600, HT-755 & HT-828
Part No. – AR5000



AIR DRYER VALVE KIT for New Style Air Dryers w/o Fins, 2008 or Newer Hurricanes
 Fits: Hurricane HT-400, HT-500, HT-600, HT-755 & HT-828
Part No. – AR5001



CHECK VALVE for AR5003 New Style Air Dryer, 2008 or Newer Hurricanes
 Fits: Hurricane HT-400, HT-500, HT-600, HT-755 & HT-828
Part No. – AR5002



120V SOLENOID for IVEC Electric Dust Collectors
Part No. – AR4015-2

SOLENOID for Baghouse Electric 120V
 Fits: Hurricane HS-500 EM & HS-800 EM
Part No. – AR4015-1

SOLENOID for Baghouse Filter Pulsing, 12V for all Diesel Powered Vacuums
 Fits: Hurricane HT-400, HT-500, HT-600, HT-755, HT-828, HS-500 EM, HS-800 EM, Quiet Cube & Vecloader
Part No. – AR4015



REBUILD KIT for Baghouse Solenoid
 Fits: Hurricane HT-400, HT-500, HT-600, HT-755, HT-828 & Vecloader
Part No. – AR4018



COMPRESSED AIR SYSTEM PARTS



ARCTIC AIR DRYER KIT for Diesel Powered Dust Collectors and Vacuums with Alcohol Kit
Part No. – DCP1001

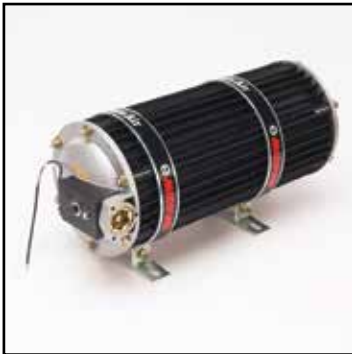

AIR DRYER for Hurricane 1998-2006 w/Fins
Fits: Hurricane HT-500, HT-600, HT-755, HT-828 & Vecloader
Part No. – AR4011



AIR DRYER for 2006 + Hurricanes
Fits: Hurricane HT-400, HT-500, HT-600, HT-755 & HT-828
Part No. – AR5003



SAFETY BLOW OFF VALVE for AR4011 w/Fins
Fits: Hurricane HT-500, HT-600, HT-755, HT-828 & Vecloader
Part No. – AR4011-1

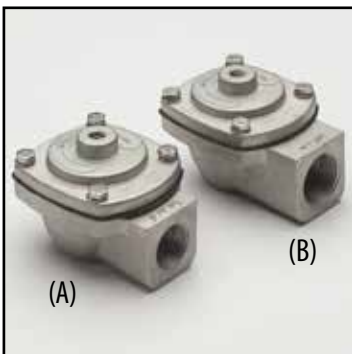

DIAPHRAGM for Baghouse Filter Pulsing – Sits Below AR4015, 3/4" NPT
Fits: Hurricane HT-400, HT-500, HT-600, HT-755, HT-828, HS-500EM, HS-800EM, Quiet Cube & Vecloader
(A) Part No. – AR4016

DIAPHRAGM VALVE for Industrial Vacuum Brand Electric Dust Collectors
Available In 1" or 1.5" NPT - Please Specify When Ordering
(B) Part No. – AR4016-2

DIAPHRAGM for IVEC 6,000, 12,000, 20,000 & 45,000 CFM Dust Collectors
(NOT SHOWN)
Part No. – AR4016-3





AIR CYLINDER – Butterfly Valve

Fits: Hurricane HT-500, HT-600, HT-755, HT-828, HS-500 EM, HS-800 EM, Quiet Cube & Vecloader

Part No. – AR4005

PIVOT BRACKET For Air Cylinder

Fits: Hurricane HT-500, HT-600, HT-755, HT-828, HS-500 EM, HS-800 EM, Quiet Cube & Vecloader

Part No. – AR4079

CLEVIS For Clutch Air Cylinder

Fits: Hurricane HT-500, HT-600, HT-755, HT-828, HS-500 EM, HS-800 EM, Quiet Cube & Vecloader

Part No. – AR4080



AIR CYLINDER for Pneumatic Dump Valve w/Square Shaft

Fits: All

Part No. – AR6000

NUT FOR AIR CYLINDER for AR6000 (NOT SHOWN)

Part No. – AR6002

CLEVIS for AR6000 (NOT SHOWN)

Fits: All **Part No. – AR6001**



ROLLER FOR PNEUMATIC DUMP VALVE

Fits: AR6000

Part No. – AR6003



AIR CYLINDER – Clutch

Fits: Vecloader 422

Part No. – AR4006



BUTTERFLY VALVE SOLENOID

Fits: Vecloader & Early Hurricane Models

Part No. – AR4007

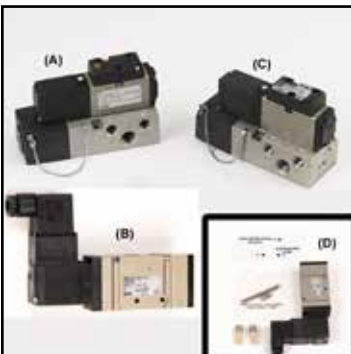

BUTTERFLY SOLENOID for Hurricane 500E/600E, 755/828 Up to 2005 Models.

After 2021 *Confirm Style When Ordering*

Fits: Hurricane HT-500, HT-600, HT-755 & HT-828

(A) Part No. – AR4201

BUTTERFLY SOLENOID for 2020 or Newer Hurricanes

Fits: Hurricane HT-500, HT-600, HT-755, HT-282, Quiet Cube, HS-800 EM w/12V System

(B) Part No. – AR7500

120V BUTTERFLY SOLENOID

Fits: Hurricane HS-500 EM & HS-800 EM w/120V System

(C) Part No. – AR4202

BUTTERFLY SOLENOID RETROFIT to replace AR4201-1

(D) Part No. – AR7500-1



ELECTRICAL SOCKET

for AR4007

Fits: Vecloader

Part No. – AR4008



COMPRESSED AIR SYSTEM PARTS



AIR ACTUATED BUTTERFLY VALVE
for 2014 or Newer Hurricanes
Fits: Hurricane HT-500, HT-600, HS-500 EM,
HS-800 EM, QC-75, QC-100 & QC-150
Part No. – AR4038

4" AIR OPERATED BUTTERFLY VALVE for Hurricane 300
Fits: Hurricane 300
Part No. – VP300E-01

6" AIR ACTUATED BUTTERFLY VALVE
for Catalyst Units
Fits: Hurricane HT-600 & HT-755
Part No. – AR4041

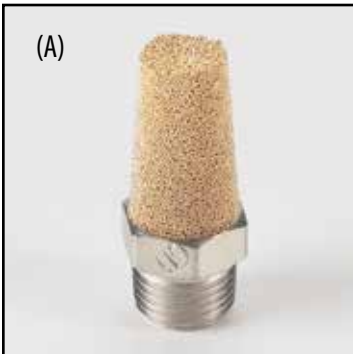

BRASS BREATHER 1/8" NPT
Fits: Hurricane HT-500, HT-600, HT-755, HT-828, HS-500 EM,
HS-800 EM & Vecloder
(A) Part No. – AR4034

BRASS BREATHER 1/4" NPT for Air Cylinder and Solenoid Ports
Fits: Hurricane HT-500, HT-600, HT-755, HT-828, HS-500 EM,
HS-800 EM & Vecloder
(B) Part No. – AR4035



VIBRATOR SOLENOID
Fits: Vecloder Only
Part No. – AR4075



MAIN AIR TANK
Fits: Hurricane HT-400, HT-500, HT-600, HT-755 & HT-828
Part No. – AR4901



8" REAR BAGHOUSE AIR TANK
Fits: Hurricane HT-500, HT-600, HT-755, HT-828, HS-500 EM, HS-800 EM & Vecloder
Part No. – AR4021





AUXILIARY VALVE
Ingersoll Rand
Fits: Vecloader
Part No. – AR4004



SAFETY VALVE –150 PSI
Fits: Hurricane HT-500,
HT-600, HT-755, HT-828
& Vecloader
Part No. – AR4012



LUBRICATOR for Vibrator
Fits: Hurricane HT-500, HT-600,
HT-755, HT-828, HS-500 EM,
HS-800 EM, Quiet Cube
& Vecloader
Part No. – AR4076



MOUNTING BRACKET
for AR4076 Lubricator
Fits: Hurricane HT-500, HT-600,
HT-755, HT-828, HS-500 EM,
HS-800 EM, Quiet Cube
& Vecloader
Part No. – AR4077

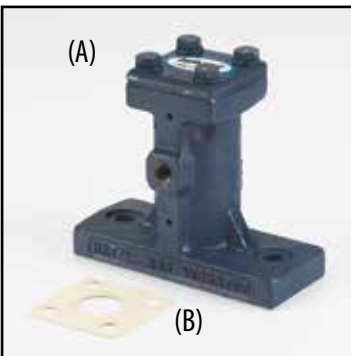

IMPACTING CONE VIBRATOR
Fits: Hurricane HT-500, HT-600, HT-755, HT-828, HS-500 EM, HS-800 EM, Quiet Cube & Vecloader
(A) Part No. – AR4010

GASKET
(B) Part No. – AR4010-1



AIR COMPRESSOR GOVERNOR for All Hurricane Diesels
Fits: Hurricane HT-400, HT-500, HT-600, HT-755, HT-828 & Vecloader
Part No. – AR4031



AIR SWITCH Blower ON / OFF
Fits: Vecloader
Part No. – AR4009



COMPRESSED AIR SYSTEM PARTS



VIBRATOR FLOW CONTROL

Fits: Hurricane HT-400, HT-500, HT-600, HT-755 & HT-828

Part No. – AR4013

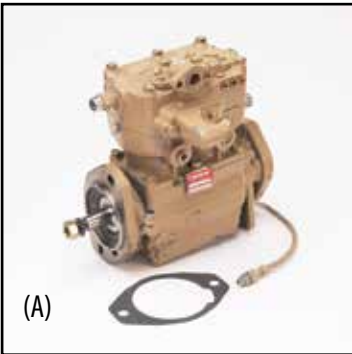

(A)



(B)

AIR COMPRESSOR – Auxiliary Drive

Fits: Hurricane HT-400, HT-500, HT-600, HT-755 & HT-828

(A) Part No. – AR4902

AIR COMPRESSOR – New Style Twin Cylinder Auxiliary Drive

Fits: Hurricane HT-400, HT-500, HT-600, HT-755 & HT-828

(B) Part No. – AR4910

SAFETY VALVE – New Style (AR4910) Air Compressor

Fits: Hurricane HT-400, HT-500, HT-600, HT-755 & HT-828

Part No. – AR4909

REBUILT AIR COMPRESSOR - Auxiliary Drive (Core Required)

Fits: Hurricane HT-400, HT-500, HT-600, HT-755 & HT-828

Part No. – AR4902R

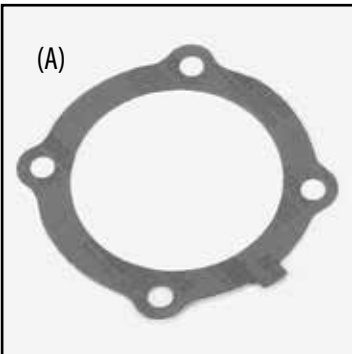

(A)

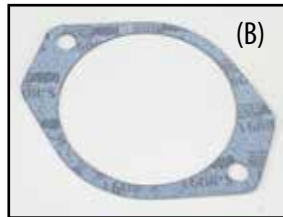

(B)



(C)

GASKET Between Thru Drive and Air Compressor

Fits: Hurricane HT-400, HT-500, HT-600, HT-755 & HT-828

(A) Part No. – AR4904

GASKET for Air Compressor for New Style Bendix Air Compressors

Fits: Hurricane HT-500, HT-600, HT-755 & HT-828

(B) Part No. – AR4910-1

GASKET for Air Compressor AR4910

Fits: Hurricane HT-400, HT-500, HT-600, HT-755 & HT-828

(C) Part No. – AR4918

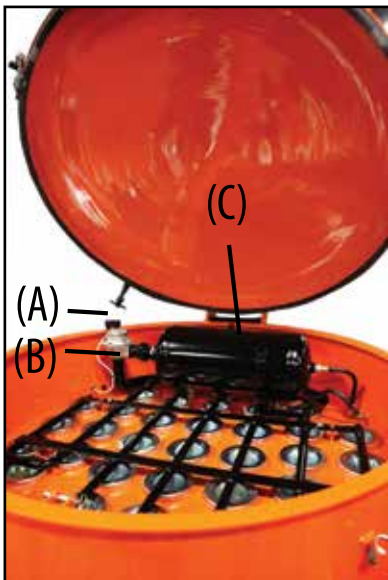

(A)

(B)

(C)

AIR CANNON PRE-WIRED DIN CABLE

Fits: New Hurricane HT-500, HT-600 & HS-500 EM with Air Cannon System

(A) Part No. – AR5208

AIR CANNON 12 VOLT SOLENOID

Fits: New Hurricane HT-500, HT-600 & HS-500 EM with Air Cannon System

(B) Part No. – DCP0015-3

AIR CANNON 1-1/2" DIAPHRAGM VALVE

Part No. – AR5207

AIR CANNON DIAPHRAGM REBUILD KIT

Part No. – AR4017-3

AIR CANNON TANK ONLY

Fits: New Hurricane HT-500, HT-600 & HS-500 EM with Air Cannon System

(C) Part No. – AR5200

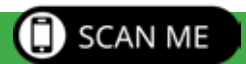



COILED AIR HOSE from Tower to Baghouse

Fits: Hurricane HT-400, HT-500, HT-600, HT-755, HT-828 & Vecloader

Part No. – AR4014



(A)

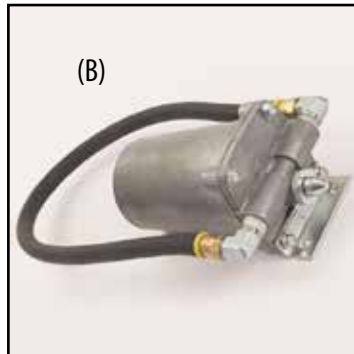

(B)

ALCOHOL EVAPORATOR – for cold weather operation

Option

(A) Part No. – AR4030

ALCOHOL EVAPORATOR ASSEMBLY – w/Hoses for Cold Operation

(B) Part No. – AR4030-A



AIR PRESSURE GAUGE for Hurricane Models (Tank Mount)

Fits: Hurricane HT-500 & HT-600

Part No. – AR4203



BRAIDED STEEL AIR LINE Compressor to Air Dryer for Vecloader (Shown)

Fits: Vecloader

Part No. – AR4003

BRAIDED STEEL AIR LINE Compressor to Air Dryer for All Hurricane Diesels

Fits: Hurricane HT-500, HT-600, HT-755 & HT-828

Part No. – AR4787



(A)



(B)

CHECK VALVE ON BAGHOUSE

Fits: Hurricane HT-400, HT-500, HT-600, HT-755, HT-828, HS-500 EM, HS-800 EM & Quiet Cube

(A) Part No. – AR4036

MAIN AIR TANK CHECK VALVE

for All Hurricane Diesels

Fits: Hurricane HT-400, HT-500, HT-600, HT-755 & HT-828

(B) Part No. – AR4037



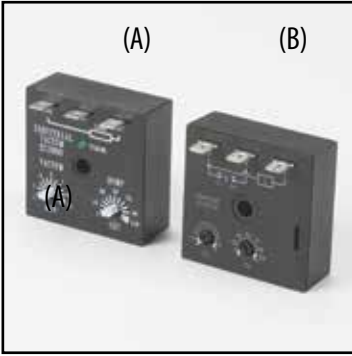

DUMP TIMER VARIABLE

Fits: Hurricane HT-400, HT-500, HT-600, HT-755, HT-828, Quiet Cube & Vecloder

(A) Part No. – EC2000

DUMP TIMER 120V

Fits: All IVEC Electric Dust Collectors

(B) Part No. – EC2000-1

12 VOLT DUMP TIMER - Special 100 Minutes On, 100 Seconds Off

Fits: Hurricane HT-300, HT-400, HT-500, HT-600, HT-755, HT-828, Quiet Cube & Vecloder

Part No. – EC2000-2

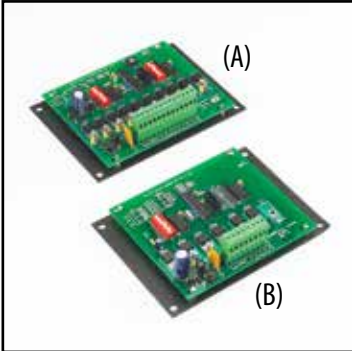

BAGHOUSE TIMER BOARD – 10 STATION 12V

Fits: Dust Collector

(A) Part No. – EC2001-10

BAGHOUSE TIMER BOARD

Fits: Hurricane HT-400, HT-500, HT-600, HT-755, HT-828, Quiet Cube & Vecloder

(B) Part No. – EC2001



BAGHOUSE TIMER – 120V (Hurricane)

Fits: Hurricane Electric Models w/120V Baghouse

Part No. – EC2013

BAGHOUSE TIMER – for 20,000CFM Electric Dust Collectors

Part No. – EC2001-22



COILED CABLE - 6 Wire Tower to Baghouse

Fits: Hurricane HT-400, HT-500, HT-600, HT-755 & HT-828

Part No. – EC2002

4 WIRE x 4 FOOT COILED CABLE - For Electric Skid Mounted Vacuums

Fits: HS-500EM, HS-800EM & Quiet Cube

Part No. – EC2002-1

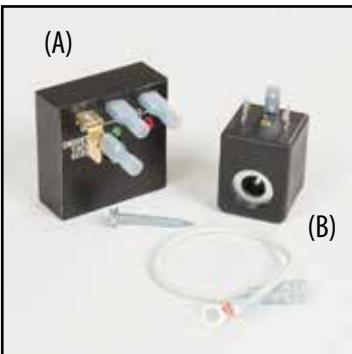

AIR CANNON RETROFIT KIT

Fits: All Hurricanes with Air Cannon System (Shown)

Part No. – EC6002

AIR CANNON SOLENOID

Fits: All Hurricanes with Air Cannon System

(B) Part No – DCP0015-3

AIR CANNON PLUS TIMER

Fits: All Hurricanes with Air Cannon System

(A) Part No. – EC2015





REMOTE EMERGENCY STOP CONTROL BOX with 50' Extension Cable (Shown)
Fits: Hurricane HT-400, HT-500, HT-600, HT-755, HT-828, HS-500 EM & HS-800 EM
Part No. – EC2027

REMOTE EMERGENCY STOP CONTROL BOX with 100' Extension Cable
Fits: Hurricane HT-400, HT-500, HT-600, HT-755, HT-828, HS-500 EM & HS-800 EM
Part No. – EC2027-100

REMOTE EMERGENCY STOP 100' EXTENSION CABLE – Male/Female Twist Locks
Fits: All
Part No. – EC2027-1



REMOTE EMERGENCY STOP BOX w/o Cable or Twist Lock (Shown)
Fits: Hurricane HT-400, HT-500, HT-600, HT-755, HT-828, HS-500 EM & HS-800 EM
Part No. – EC2029
REMOTE WIRELESS E-STOP
Fits: All
Part No. – EC2027R



REMOTE EMERGENCY STOP ASSEMBLY for Auger w/forward reverse and cord
Part No. – EC2041



WIRING HARNESS for Baghouse
Fits: Hurricane HT-400, HT-500, HT-600, HT-755 & HT-828
Part No. – EC2220



MATRIX-3 WIRING
Fits: Hurricane HT-300
Part No. – VP300-019



CONTACT BLOCK for Emergency Stop Button
Fits: Hurricane HT-400, HT-500, HT-600, HT-755 & HT-828
Part No. – EC2030



SOLENOID for Matrix-3 Wiring
Fits: Hurricane HT-300
Part No. – DCP0015-3

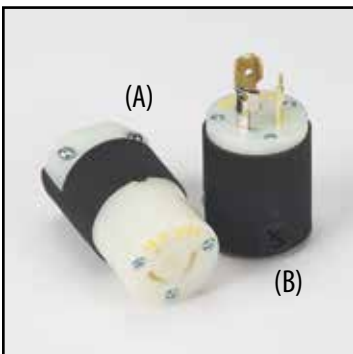

TWIST LOCK CORD CONNECTORS – Female
Fits: Hurricane HT-400, HT-500, HT-600, HT-755 & HT-828
(A) Part No. – EC2215
TWIST LOCK CORD CONNECTORS – Male
Fits: Hurricane HT-400, HT-500, HT-600, HT-755 & HT-828
(B) Part No. – EC2216



ELECTRICAL SYSTEM PARTS



CLEARANCE LIGHT – AMBER for older Vecloader and Hurricanes (Rectangle Shape)

Fits: Vecloader

(A) Part No. – EC2016

CLEARANCE LIGHT – RED for older Vecloader and Hurricanes (Rectangle Shape)

Fits: Vecloader, Hurricane 555 & 655

(B) Part No. – EC2017



REAR CLEARANCE LIGHT BRACKET

Part No. – EC2028

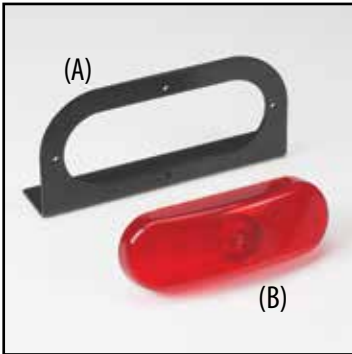

HURRICANE TAIL LIGHT MOUNTING BRACKET

Fits: Hurricane HT-300, HT-400, HT-500, HT-600, HT-755 & HT-828

(A) Part No. – EC2024-1

HURRICANE TAIL LIGHT GROMMET

Fits: Hurricane HT-300, HT-400, HT-500, HT-600, HT-755 & HT-828

(A) Part No. – EC2024-2

HURRICANE TAIL LIGHT

Fits: Hurricane HT-300, HT-400, HT-500, HT-600, HT-755 & HT-828

(B) Part No. – EC2024

HURRICANE TAIL LIGHT PIG TAIL WIRE for EC2024

Fits: Hurricane HT-300, HT-400, HT-500, HT-600, HT-755 & HT-828

Part No. – EC2037

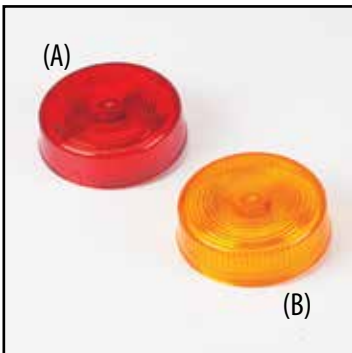

HURRICANE CLEARANCE LIGHT for Frame / Rear Top of Baghouse – Red 2.5" Round

Fits: Hurricane HT-400, HT-500, HT-600, HT-755 & HT-828

(A) Part No. – EC2025

HURRICANE CLEARANCE LIGHT for Frame – Amber 2.5" Round

Fits: Hurricane HT-400, HT-500, HT-600, HT-755 & HT-828

(B) Part No. – EC2025-Y



CLEARANCE LIGHT MOUNTING BRACKET for 2.5" Round

Fits: Hurricane HT-400, HT-500, HT-600, HT-755 & HT-828

(A) Part No. – EC2025-1

HURRICANE CLEARANCE LIGHT for Tower – Amber 2" Round

Fits: Hurricane HT-400, HT-500, HT-600, HT-755 & HT-828

(B) Part No. – EC2025TY

HURRICANE CLEARANCE LIGHT for Tower – Red 2" Round

Fits: Hurricane HT-400, HT-500, HT-600, HT-755 & HT-828

(B) Part No. – EC2025T

HURRICANE CLEARANCE LIGHT PIG TAIL WIRE for EC2025-1

Fits: Hurricane HT-400, HT-500, HT-600, HT-755 & HT-828

Part No. – EC2037-1





RUBBER GROMMET for Clearance Light 2.5"
Fits: Hurricane HT-400, HT-500, HT-600, HT-755 & HT-828
Part No. – EC2026

RUBBER GROMMET for Tower Clearance Light 2"
Fits: Hurricane HT-400, HT-500, HT-600, HT-755 & HT-828
Part No. – EC2026T

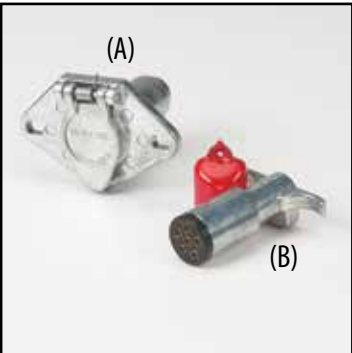

6 WIRE TRAILER PLUG – Female
(A) Part No. – EC2020

6 WIRE TRAILER PLUG – Male
(B) Part No. – EC2020-1

JUNCTION BOX for Hurricane Trailer Lights
Fits: Hurricane HT-400, HT-500, HT-600, HT-755, HT-828 & Vecloader
Part No. – EC2022



7 PIN HURRICANE TRAILER LIGHT ADAPTER
Fits: Hurricane HT-400, HT-500, HT-600, HT-755 & HT-828
Part No. – EC2020-2



PRESSURE SWITCH
Fits: Hurricane HT-755 & HT-828
Part No. – EC2212

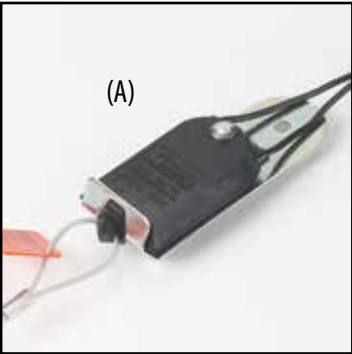

BREAKAWAY ASSEMBLY
Fits: Hurricane HT-400, HT-500, HT-600, HT-755 & HT-828
(A) Part No. – EC2034

FUSE HOLDER – Panel Mount
Fits: Vecloader
(B) Part No. – EC2003



DIRTY FILTER SHUT DOWN SYSTEM for Hurricane Model 755/828
Fits: Hurricane HT-755 & HT-828
Part No. – EC2217



ELECTRICAL SYSTEM PARTS



PILOT LIGHT Asbestos Controls
Fits: Vecloder
Part No. – EC2004



EMERGENCY STOP BUTTON
Asbestos Controls
Fits: Vecloder
Part No. – EC2005



E-STOP FOR WORLD WIDE CONTROL PANELS
Fits: HS-500 EM, HS-800 EM & Quiet Cube
(A) Part No. – EC8001

SELECTOR SWITCH FOR BAG HOUSE AND DUMP
Fits: HS-800 EM & Quiet Cube
(B) Part No. – EC8000



NORMALLY OPEN CONTACT BLOCK
Fits: Vecloder
Part No. – EC2006



NORMALLY CLOSED CONTACT BLOCK (Goes w/EC2005)
Fits: Vecloder
Part No. – EC2007



2-POSITION SELECTOR SWITCH
Fits: Vecloder
Part No. – EC2008





PUSH BUTTON LIMIT SWITCH
Asbestos Controls
Fits: Vecloder
Part No. – EC2009

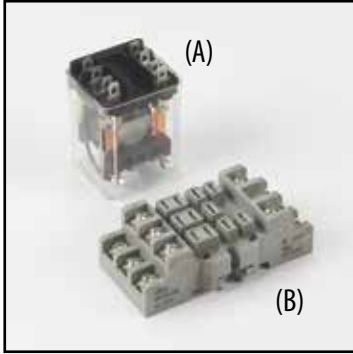

12V RELAY –
Vibrator or Asbestos Controls
Fits: Vecloder
(A) Part No. – EC2010
RELAY SOCKET for EC2010
Fits: Vecloder
(B) Part No. – EC2011



INTERVAL TIMER
for Asbestos Controls
Fits: Vecloder
Part No. – EC2012



POTENTIOMETER – Rear Timer
Control on Asbestos Models
Fits: Vecloder 522 Asbestos
Part No. – EC2014

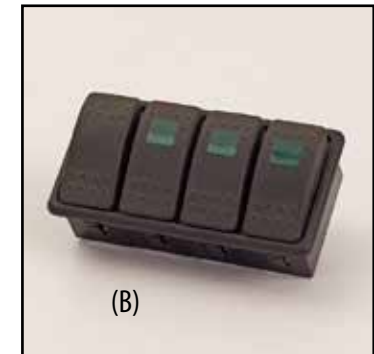

TOGGLE SWITCH – On/Off
Fits: Hurricane HT-400, HT-500, HT-600, HT-755 & HT-828
(A) Part No. – EC2033

ROCKER SWITCH ASSEMBLY
Fits: All Hurricane Models
(B) Part No. – EC2200

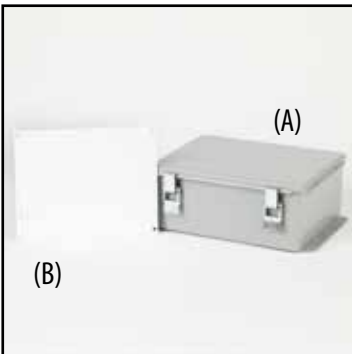

8" x 10" ELECTRICAL BOX
Hurricane Baghouse
Fits: Hurricane HT-400, HT-500,
HT-600, HT-755, HT-828,
HS-500 EM, & Quiet Cube Models
(A) Part No. – EC2204A
8" x 10" ELECTRICAL BOX
INTERIOR PANEL for EC2204A
(B) Part No. – EC2204A-1

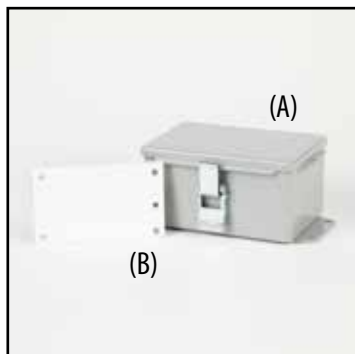

4x6 JIC BOX WITH HINGE
Fits: Hurricane HT-400, HT-500,
HT-600, HT-755, HT-828,
HS-500 EM, & Quiet Cube Models
(A) Part No. – EC2206
4x6 JIC BOX INNER PANEL
for EC2206
(B) Part No. – EC2206A

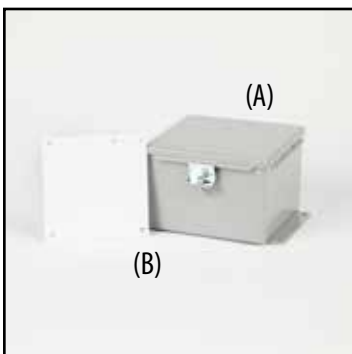

6x6 JIC BOX WITH HINGE FOR
HURRICANES WITH AIR CANNON
Fits: Hurricane HT-500, HT-600,
HS-500 EM & QC-150
(A) Part No. – EC2205A
6x6 JIC BOX INNER PANEL
for EC2205A
(B) Part No. – EC2205-1





SET OF KEYS

Fits: HT-400, HT-500, HT-600, HT-755, HT-828 & Vecloader

Part No. – ED0001-1

HURRICANE 300 KEY

Fits: HT-300

Part No. – VP300D-15

KOHLER KEY

Part No – ED0001-7

KUBOTA ENGINE KEY

Fits: HT-300

Part No. – VP300D-02

KOHLER KEY SWITCH

Part No. – ED0001-6



IGNITION SWITCH

Fits: HT-400, HT-500, HT-600, HT-755, HT-828 & Vecloader

Part No. – ED0001

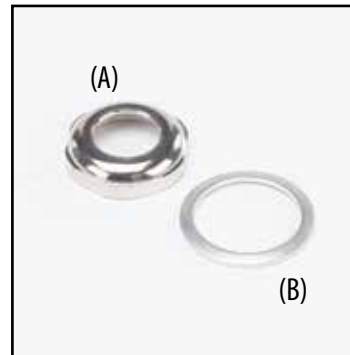

NUT FOR KEY SWITCH

Fits: HT-400, HT-500, HT-600, HT-755, HT-828 & Vecloader

(A) Part No. – ED0002

WASHER FOR KEY SWITCH

Fits: HT-400, HT-500, HT-600, HT-755, HT-828 & Vecloader

(B) Part No. – ED0003



TACHOMETER w/ Hour Meter
Mechanical (Shown)

Fits: Vecloader

Part No. – ED0005

12V HOUR METER for Vecloader

Fits: Vecloader

Part No. – ED0048



AMMETER

Fits: Vecloader

Part No. – ED0009



BATTERY HOLD-DOWN BRACKET

Fits: Hurricane HT-500 & HT-600

Part No. – ED9003



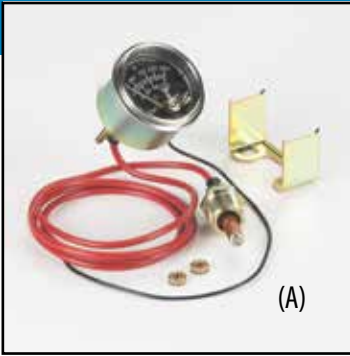

(A)



(B)

TEMPERATURE GAUGE for Vecloders

Fits: Vecloder

(A) Part No. – ED0010

TEMPERATURE GAUGE for Hurricanes

Fits: Hurricane HT-555 & HT-655

(B) Part No. – ED0010-8



OIL PRESSURE GAUGE

Fits: Vecloder

Part No. – ED0011

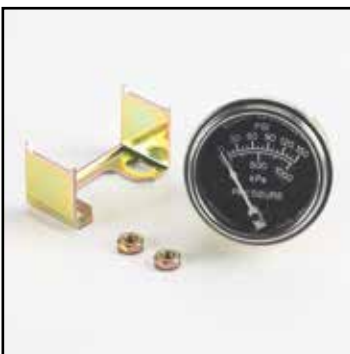

AIR PRESSURE GAUGE

Fits: All Panel Mount Applications

Part No. – ED0012



TACHOMETER for Hurricanes

Fits: Hurricane HT-555 & HT-655

Part No. – ED0031



TIER 4 CONTROLLER DISPLAY – KOHLER ENGINE

Fits: Hurricane HT-500, HT-600, HT-755 & HT-828 with Kohler Tier 4 Engine

Part No. – ED1002-T4K



ENGINE CONTROL PANEL (Powerview) Shown

Fits: Hurricane HT-500, HT-600, HT-755 & HT-828

Part No. – ED1002

TIER 4 CONTROLLER DISPLAY – JOHN DEERE ENGINE

Fits: Hurricane HT-500, HT-600, HT-755 & HT-828 with John Deere Tier 4 Engine

Part No. – ED1002-T4



ENGINE & DRIVE PARTS



PUSH BUTTON MURPHY SAFETY SWITCH

Fits: Vecloader
Part No. – ED0013



PUSH BUTTON MURPHY SAFETY SWITCH for Hurricanes

Fits: Hurricane HT-500, HT-600, HT-555 & HT-655
Part No. – ED0013H



VACUUM GAUGE 0-30hg Bottom Mount

Fits: Vecloader
(A) Part No. – ED0014

VACUUM GAUGE MOUNTING BRACKET

Rubber Isolated, Back Mount
 Fits: Hurricane HT-400, HT-500, HT-600, HT-755, HT-828, HS-500 EM & HS-800 EM
(B) Part No. – ED0014-1

VACUUM GAUGE 0-30hg Back Mount

Fits: Hurricane HT-400, HT-500, HT-600, HT-755, HT-828, HS-500 EM & HS-800 EM
Part No. – ED0014-2

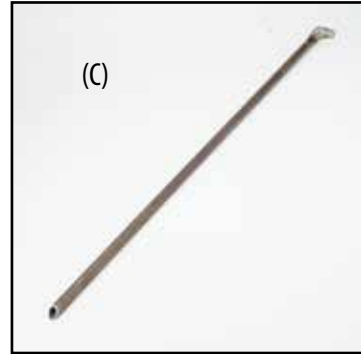
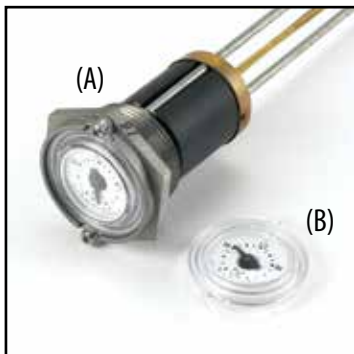

15" FUEL GAUGE Fits: Vecloader

(A) Part No. – ED0036

15" FUEL GAUGE DIAL Fits: Vecloader

(B) Part No. – ED0036-1

29" FUEL GAUGE for Hurricane Diesels

Part No. – ED0036H

FUEL GAUGE for Hurricane HT-300

Part No. – VP300D-022

FUEL TANK PICK UP TUBE for All Hurricane Diesels

Fits: Hurricane HT-400, HT-500, HT-600, HT-755 & HT-828
(C) Part No. – ED0036-2



THROTTLE CABLE

Fits: Vecloader 422/522
Part No. – ED0004



HURRICANE THROTTLE CABLE – 500E/600E Tier I

Fits: Hurricane HT-500 & HT-600
Part No. – ED0004-1



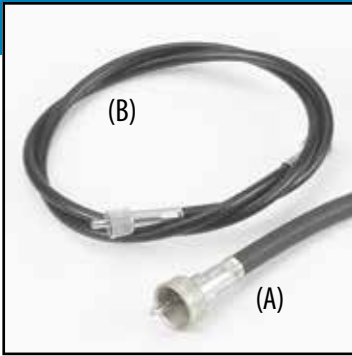

TACHOMETER CABLE

Fits: Vecloader

(A) Part No. – ED0049

TACHOMETER CABLE

Fits: Vecloader 422/522

(B) Part No. – ED0049-1



ENGINE OIL FILTER for Vecloaders (Shown)

Fits: Vecloader 422/522

Part No. – ED0007

OIL FILTER for Hurricane – 170-225hp

Fits: Hurricane HT-555 & HT-655

Part No. – ED0007-1

OIL FILTER for Hurricane – Tier 2 & 3, 170-225hp &

Hurricane 400, 75hp

Fits: Hurricane HT-400, HT-500, HT-600 & HT-755

Part No. – ED0007-2

OIL FILTER for Hurricane HT-300

Part No. – VP300D-11

OIL FILTER for 156hp Tier 4 John Deere Engine

Fits: Hurricane HT-500, HT-600 & HT-755 Tier 4

Part No. – EDJ0007-T4

OIL FILTER for 325hp Tier 4 John Deere Engine

Fits: Hurricane HT-828 Tier 4

Part No. – ED0107T4

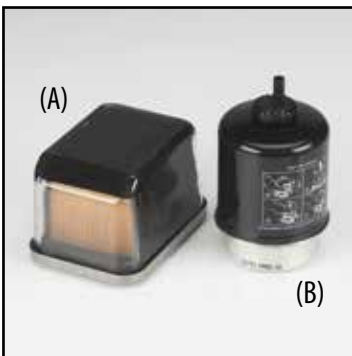

ENGINE FUEL FILTERS for Vecloaders 422/522

(A) Part No. – ED0008

ENGINE FUEL FILTERS for Hurricane

Part No. – ED0008-1

FUEL FILTER – Tier 2 Electronic Engines (170hp)

from Pump/Injectors

Fits: Hurricane HT-500 & HT-600

(B) Part No. – ED0008-2

FUEL FILTER – Tier 2 Electronic Engines (170hp-225hp)

from Tank/Pump Fits: Hurricane HT-500, HT-600 & HT-755

Part No. – ED0008-3

FUEL FILTER – Tier 2 Electronic Engines (225hp)

from Pump/Injectors Fits: Hurricane HT-755

Part No. – ED0008-4

FUEL FILTER – Tier 3 Engine 500/600/755 Models (170hp-225hp)

Fits: Hurricane HT-500, HT-600 & HT-755

Part No. – ED0008T3-1

FUEL FILTER for Hurricane HT-300

Part No. – VP300D-12

FUEL FILTER ASSEMBLY for Hurricane HT-300

Part No. – VP300D-13



OIL FILTER HOUSING SEAL

Part No. – ED0007-4



ENGINE & DRIVE PARTS



FUEL FILTER for 156hp & 225hp Tier 4
John Deere Diesel Engine
Fits: Hurricane HT-500, HT-600 & HT-755 Tier 4
Part No. EDJ0008-T4

SECONDARY FUEL FILTER – Tier 3 Engine
500/600/755 Models (170hp-225hp)
Fits: Hurricane HT-500, HT-600 & HT-755
Part No. – ED0008T3-2

HURRICANE 828 TIER 3 FUEL FILTER
Part No. – ED0008-8

PRIMARY FUEL FILTER Tier 4 Engine 828
Model (325 hp)
Fits: Hurricane HT-828 Tier 4
Part No. – ED0108T4-1

SECONDARY FUEL FILTER Tier 4 Engine 828
Model (325 hp)
Fits: Hurricane HT-828 Tier 4
Part No. – ED0108T4-2



PRIMARY FUEL FILTER Tier 2 Engine 828 Model (325 hp)
Fits: Hurricane HT-828
(A) Part No. – ED2828

PRIMARY FUEL FILTER Tier 2 Engine 828 Model (320 hp)
Fits: Hurricane HT-828
(B) Part No. – ED2828-1

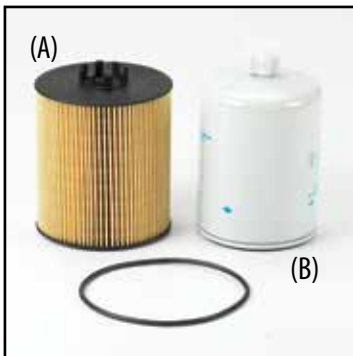

SECONDARY FUEL FILTER KIT Tier 2 Engine 828 Model (325 hp) Includes “O” Ring
Fits: Hurricane HT-828
(A) Part No. – ED2829

SECONDARY FUEL FILTER Tier 2 Engine 828 Model (320 hp) Includes “O” Ring
Fits: Hurricane HT-828
(B) Part No. – ED2829-1



LARGE ENGINE AIR CLEANER – Hurricane 555/655
and older Vecloaders (Shown)
Fits: Hurricane HT-555, HT-655 & Vecloder 422/522
Part No. – ED0015

LARGE ENGINE AIR CLEANER
Fits: 500EL 100hp Tier 1
Part No. – ED0015-1

LARGE ENGINE AIR CLEANER – Hurricane 500E/600E
Fits: Hurricane HT-500E & HT-600E Tier 1
Part No. – ED0015E

LARGE ENGINE AIR CLEANER – Hurricane 755
Fits: Hurricane HT-755 Tier 1
Part No. – ED0015H

LARGE ENGINE AIR CLEANER for 500E, 600E, 755
w/Tier 2 & 3 Engines
Fits: Hurricane HT-500, HT-600 & HT-755
Part No. – ED0016-2

LARGE ENGINE (PRIMARY) AIR CLEANER for 2018
or Newer Hurricane 500, 600, 755 Tier 3 Engines
Fits: Hurricane HT-500, HT-600 & HT-755 Tier 3
Part No. EDJ0016-P

LARGE ENGINE (PRIMARY) AIR CLEANER for
156 & 225hp Tier 4 John Deere Engines
Fits: Hurricane HT-500, HT-600 & HT-755 Tier 4
Part No. EDJ0016-T4P



OIL DRAIN HOSE ASSEMBLY
Fits: Hurricane HT-300
Part No. – VP300D-07





When ordering air cleaner for 828 Models, engine serial number needed.

SMALL ENGINE AIR CLEANER for 170 & 225hp Tier 2 & 3 Engines

Fits: Hurricane HT-500, HT-600 & HT-755

Part No. – ED0016-1

SMALL ENGINE AIR CLEANER – Hurricane 555/655, Older Vecloders, 422 & 522

Fits: Hurricane HT-555, HT-655 & Vecloder 422/522

Part No. – ED0016

SMALL ENGINE AIR CLEANER – 500, 600, Tier 2 & 100hp Tier 1

Fits: Hurricane HT-500, HT-600 & 500EL

Part No. – ED0016-3

SMALL ENGINE AIR CLEANER – All “E” Models

Fits: Hurricane HT-500 & HT-600 Tier 1

Part No. – ED0016E

SMALL ENGINE AIR FILTER – Hurricane 755

Fits: Hurricane HT-755 Tier 1

Part No. – ED0016H

SMALL ENGINE AIR CLEANER for 2017 or Newer Hurricane 500, 600, 755 Tier 3 Engines

Fits: Hurricane HT-500, HT-600, & HT-755 Tier 3

Part No. – EDJ0016-S

SMALL ENGINE (SECONDARY) AIR CLEANER for 156 & 225hp Tier 4 John Deere Engines

Fits: Hurricane HT-500, HT-600, HT-755 Tier 4

Part No. – EDJ0016-T4S

SMALL ENGINE (SECONDARY) AIR CLEANER for Hurricane 828 (325 hp)

Fits: Hurricane HT-828 Tier 4

Part No. – ED0116T4-2



(A)



(B)

AIR CLEANER INTAKE BASKET – Raincap

Fits: Hurricane HT-500 & HT-600

(A) Part No. – ED1004

HURRICANE AIR CLEANER END COVER

Fits: Hurricane HT-500 & HT-600

(B) Part No. – ED1006

AIR CLEANER CHECK VALVE for ED1006 - Not Shown

Fits: Hurricane HT-500 & HT-600

Part No. – ED1006-1

AIR CLEANER END CAP

Fits: 2018-2019 Hurricane HT-500 & HT-600

Part No. – ED1006-4

AIR CLEANER CLIP

Fits: 2018-2019 Hurricane HT-500 & HT-600

Part No. – ED1006-5



“O” RING for Air Cleaner Cover

Fits: Hurricane HT-500 & HT-600

Part No. – ED1007



METAL AIR CLEANER CAP for

Vecloder 522, Hurricane 655 & 555

Fits: Hurricane HT-555, HT-655 &

Vecloder 422/522

Part No. – ED0038

RUBBER BAFFLE for ED0038

Fits: Vecloder 422/522/622

Part No. – ED0037



AIR FILTER

Fits: Hurricane HT-400

Part No. – ED0015-4



ENGINE & DRIVE PARTS



PTO – CLUTCH for Hurricane Model 500E / 600E

Fits: Hurricane HT-500 & HT-600

Part No. – ED0006H

PTO – CLUTCH 10"

Fits: Vecloader 422/522

Part No. – ED0006

HURRICANE 755 PTO CLUTCH – Complete Unit With Pilot Bearing

Fits: Hurricane HT-755

Part No. – ED0051

Note: We have clutches for all types of vacuums and dust collectors available. Call or email for pricing.



10" CLUTCH ASSEMBLY – Not Including Bell Housing or Shaft

Fits: Vecloader

Part No. – ED0034

HURRICANE 755 CLUTCH ASSEMBLY – For NACD Clutch Only

Fits: Hurricane HT-755

Part No. – ED0051-1

11.5" CLUTCH ASSEMBLY – Not Including Bell Housing or Shaft

Fits: Hurricane HT-500 & HT-600

Part No. – ED0034H

CLUTCH ASSEMBLY for Hurricane 500/600/500EL Models with NACD/IVEC clutch. Not Including Bell Housing or Shaft

Part No. – ED0034-1



10" DRIVE RING GEAR

Fits: Vecloader 422/522

Part No. – ED0033

11.5" DRIVE RING GEAR

Fits: Hurricane HT-500 & HT-600

Part No. – ED0033H

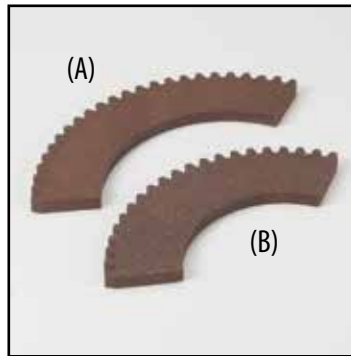

11.5" CLUTCH DISKS for Hurricane

Fits: Hurricane HT-500 & HT-600

Part No. – ED0032H

10" CLUTCH DISKS for Vecloader

Fits: Vecloader 422/522

Part No. – ED0032



PILOT BEARING for Hurricane

500/600E Models (Shown)

Fits: Hurricane HT-500,
HT-600 & 500-EL

Part No. – ED0034H-1

PILOT BEARING

Fits: Vecloader

Part No. – ED2-07431



PTO SPLINED COUPLING

for 755 shaft extension

Part No. – ED4042-4

PTO SHAFT EXTENSION for 755

Part No. – ED4042-5





LOWER RADIATOR HOSE for Vecloder

Fits: Vecloder 522

Part No. – ED0028



UPPER RADIATOR HOSE for Vecloder

Fits: Vecloder 522

Part No. – ED0029



MUFFLER for Vecloder w/o Rain Cap

Fits: Hurricane 555/655 & Vecloder 422/522

Part No. – ED0030



RAIN CAP for Part # ED0030

Fits: Hurricane 555/655 & Vecloder 422/522

Part No. – ED0030-1



RESIDENTIAL MUFFLER for Hurricane 6 Cylinder Engine

Fits: All Diesel Models

Part No. – ED0030-R



ENGINE & DRIVE PARTS

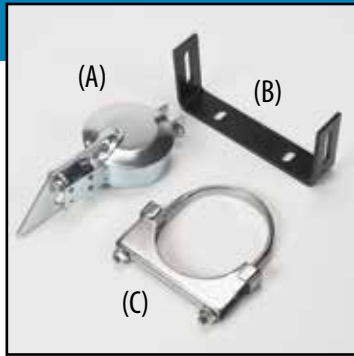

3.5" MUFFLER RAIN CAP for Hurricane 500E/600E

Fits: Hurricane HT-500 & HT-600

(A) Part No. – ED0027-4

MUFFLER BRACKET for Hurricane 500E/600E

Fits: Hurricane HT-500 & HT-600

(B) Part No. – ED0027-3

4" MUFFLER CLAMP for Hurricane 500/600

Fits: Hurricane HT-500 & HT-600

(C) Part No. – ED0027-2

3.5" MUFFLER CLAMP for Hurricane 500/600

Fits: Hurricane HT-500 & HT-600

Part No. – ED0027-5

4" RAIN CAP for Muffler ED0027

Fits: Hurricane HT-755

Part No. – ED0075

5" RAIN CAP for Muffler

Fits: Hurricane HT-828

Part No. – ED0027-8

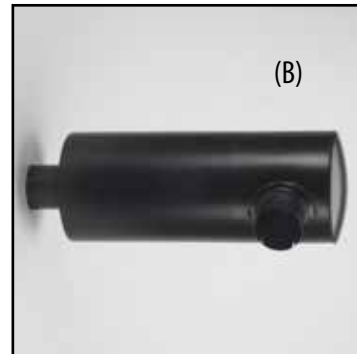
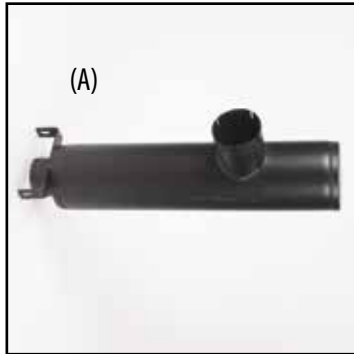

MUFFLER for Hurricane 500E/600E Tier 1 Engines

Fits: Hurricane HT-500 & HT-600

(A) Part No. – ED0027

MUFFLER ASSEMBLY for Hurricane 500E/600E

Fits: Hurricane HT-500 & HT-600 (Includes elbow & rain cap)

Part No. – ED0027A

MUFFLER for Hurricane 500E/600E Tier 2/3 Engines

Fits: Hurricane HT-500 & HT-600 Tier 2/3

(B) Part No. – ED0100



ELBOW for Hurricane Muffler – 3.5" OD

Fits: Hurricane HT-500 & HT-600

Part No. – ED0027-1

ELBOW for Hurricane Muffler – 4" OD

Fits: Tier 3 Engines

Part No. – ED0027-6



V-BELTS SVX-800 Blower Drive – Vecloaders 422/522

Fits: Vecloader

Part No. – ED0018

V-BELTS SVX-850 Blower Drive – Quiet Cube

Fits: Hurricane 500 EM Quiet Cube

Part No. – ED0018-Q

V-BELTS Hurricane Quiet Cube 200 Blower Drive

Fits: Hurricane Quiet Cube 200

Part No. – ED0018-QC200

V-BELTS Hurricane Quiet Cube 250 Blower Drive

Fits: Hurricane Quiet Cube 250

Part No. – ED0018-QC250

V-BELTS SVX-950 Blower Drive – Belt Driven Hurricanes

Fits: Hurricane HT-500, HT-600 & HS-500 EM

Part No. – ED0019

V-BELTS Hurricane Blower Drive

Fits: Hurricane HT-300 Diesel with Blower Safety Filter

Part No. – VP300D-050

V-BELTS SVX-730 Blower Drive

Fits: Hurricane HS-300 Electric

Part No. – VP300E-050

V-BELTS Hurricane Blower Drive for 156hp Tier 4 John Deere Engine

Fits: Hurricane HT-500 & HT-600 Tier 4

Part No. – ED0019-T4





V-BELT A-72 Compressor Drive
 Fits: Vecloder
Part No. – ED0020 \$20.70 each

V-BELT A-74 Compressor Drive
 Fits: Vecloder
Part No. – ED0021



IDLER BUSHING for Idler Pulley
 Fits: Vecloder
Part No. – ED0026



IDLER PULLEY ADJUSTMENT PLATE for Vecloder
 Fits: Vecloder
Part No. – ED0023-1



DIP STICK for Hurricane
 Fits: Hurricane HT-500 & HT-600
Part No. – ED0024



HIGH RPM / LOW RPM SWITCH –170 hp Hurricane
 Fits: Hurricane HT-500 & HT-600
Part No. – ED1001





THROTTLE UP & DOWN SYSTEM

for Vecloder (Shown)

Fits: Vecloder

Part No. – ED0096

THROTTLE UP & DOWN SYSTEM

for Hurricane 500/600/755

Fits: Hurricane HT-500,
HT-600 & HT-755

Part No. – ED0095



BOSCH RELAY

for Part # ED0095

Fits: Hurricane HT-500,
HT-600 & HT-755

Part No. – ED0095-1



BLOCK HEATER

for 4 Cylinder Vecloder

Fits: Vecloder

Part No. – ED0035

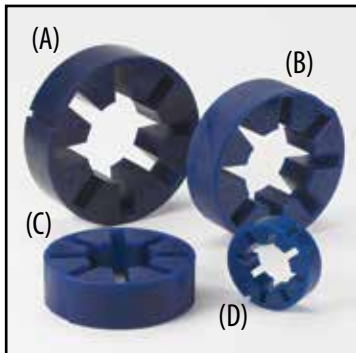

FLEX COUPLER INSERT

for Hurricane 828, 420hp

(A) Part No. – ED4043

FLEX COUPLER INSERT

for Hurricane 755 & 828, 325hp

(B) Part No. – ED4041

FLEX COUPLER INSERT

for Hurricane 755, 225hp or 250hp

(C) Part No. – ED4042

FLEX COUPLER INSERT

for Hurricane Boss Vac, 57hp

(D) Part No. – ED4044

COVER FOR FLEX COUPLER (Not Shown)

Part No. – ED4042-1

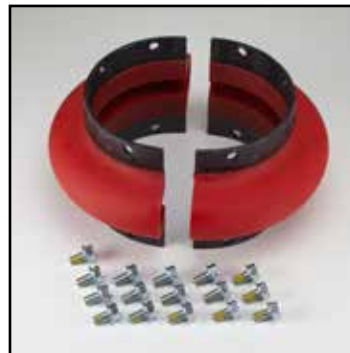

FLEX COUPLER INSERT

for Hurricane HT-828 &
HS-800 EM Blower Drive

Part No. – ED4046

PTO SHAFT DRIVE COUPLING

for Hurricane 755/828

Fits: Hurricane HT-755 & HT-828

Part No. – ED4042-3

BLOWER SHAFT DRIVE COUPLING

for Hurricane 755/828

Fits: Hurricane HT-755 & HT-828

Part No. – ED4042-2



FLEX COUPLER BUSHING -

Clutch Side

Fits: Hurricane HT-828

Part No. – ED4047



FLEX COUPLER BUSHING -

Blower Side

Fits: Hurricane HT-828

Part No. – ED4048





DRIVE PULLEY Hurricane 500 (Shown)

Fits: Hurricane HT-500

Part No. – ED70001H

DRIVE PULLEY Hurricane 600

Fits: Hurricane HT-600

Part No. – ED7000H

IDLER PULLEY Hurricane

Fits: Hurricane HT-555 & HT-655

Part No. – ED7002H

BLOWER PULLEY Hurricane 500 & 600

Fits: Hurricane HT-500 & HT-600

Part No. – ED7006H



DRIVE BUSHING – Clutch for Hurricane 500/600

Fits: Hurricane HT-500 & HT-600

Part No. – ED7001H

IDLER BUSHING for Hurricane

Fits: Hurricane HT-555 & HT-655

Part No. – ED7003H

BLOWER BUSHING for Hurricane 500

Fits: Hurricane HT-500

Part No. – ED7005H

BLOWER BUSHING for Hurricane 600

Fits: Hurricane HT-600

Part No. – ED7011H



BELT –5VX950 4-Groove Single (Shown)

Fits: Hurricane HT-500 & HT-600

Part No. – ED4950

BELT– 5VX800 4-Groove Single Banded

Fits: Vecloader

Part No. – ED4951





4" REMOVABLE INLET PIPE

Fits: Hurricane HT-300

Part No. – FAB0027

6" REMOVABLE INLET PIPE

Fits: Hurricane HT-500, HT-600,

HS-500 EM & Quiet Cube

Part No. – FAB0017

6" STAINLESS STEEL REMOVABLE INLET PIPE

Fits: Hurricane HT-500, HT-600,

HS-500 EM & Quiet Cube

Part No. – FAB0017-SS

6" OUTER INLET PIPE w/Flange

Fits: Hurricane HT-500, HT-600,

HS-500 EM & Quiet Cube

Part No. – FAB0017-1

6" STAINLESS STEEL OUTER INLET PIPE w/Flange

Fits: Hurricane HT-500, HT-600,

HS-500 EM & Quiet Cube

Part No. – FAB0017-1SS

5" INLET PIPE w/Flange

Fits: Vecloader 522

Part No. – FAB0001

8" x 6" INLET PIPE for Hurricane 755 Large Hoppers & 828 Models

Fits: Hurricane HT-755, HT-828 & HS-800 EM

Part No. – FAB1102

8" OUTER INLET PIPE-Flange (weld-in)

Fits: Hurricane HT-755, HT-828,

HS-800 EM, QC-200 & QC-250

Part No. – FAB1102-1

8" INLET PIPE

Fits: Newer Hurricane HT-755, HT-828, HS-800 EM,

QC-200 & QC-250

Part No. – FAB1103



54" CONE ASSEMBLY - For Hurricane or Vecloader, w/Flanges and Vibrator Bracket

Fits: Hurricane HT-500, HT-600, HT-755, HT-828, HS-500 EM, HS-800 EM & Vecloader

Part No. – FAB3001

54" STAINLESS STEEL CONE For Hurricane or Vecloader, w/Flanges and Vibrator Bracket

Option for FAB3001

Part No. – FAB3001-1



54" DOME for Baghouse – Hurricane 500/600

Fits: Hurricane HT-500, HT-600, HS-500 EM & Quiet Cube

Part No. – FAB3002

54" DOME for Baghouse – Hurricane 755/828 & 800 EM

Fits: Hurricane HT-755, HT-828 & HS-800 EM

Part No. – FAB3003

FLIP TOP BAGHOUSE DOME for 500/600

Fits: HT-500, HT-600, HS-500 EM & QC-150

Part No. - FAB3002-2

FLIP TOP BAGHOUSE DOME for 755/828

Fits: HT-755, HT-828 & HS-800 EM

Part No. – FAB3003-1

FLIP TOP LID HINGE ASSEMBLY for FAB3002-2

& FAB3003-1

Part No. – FAB3013

*Does not include Dome





54" DOME for Baghouse –
New Style, Boltless w/Gasket,
Hinge Arms, Latch Brackets
Fits: Hurricane HT-500, HT-600,
HS-500 EM & Quiet Cube
Part No. – FAB2999

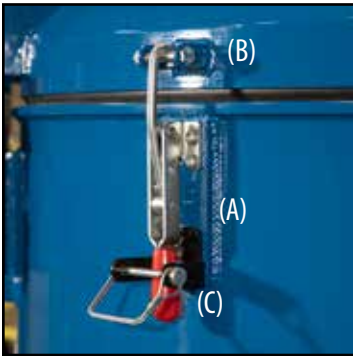

NEW STYLE BOLT LESS DOME TOGGLE CLAMP for FAB2999
(A) Part No. – MC9285
NEW STYLE BOLT LESS DOME LATCH PLATE for FAB2999
(B) Part No. – MC9286
LOWER DOME LATCH BRACKET, BLACK COATED for FAB2999
(C) Part No. – MC9287

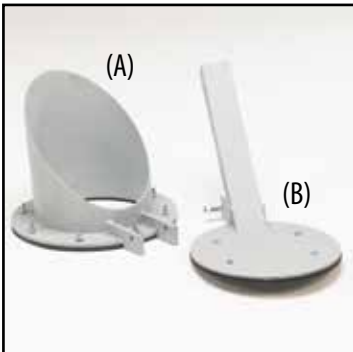

DUMP DOOR ASSEMBLY
Fits: Hurricane HT-400, HT-500, HT-600,
HT-755, HT-828, HS-500 EM, HS-800 EM, Quiet Cube & Vecloader
(A&B) Part No. – FAB9506

DUMP CHUTE ONLY
Fits: Hurricane HT-400, HT-500, HT-600, HT-755,
HT-828, HS-500 EM, HS-800 EM, Quiet Cube & Vecloader
(A) Part No. – FAB9506-2

DUMP DOOR ONLY
Fits: Hurricane HT-400, HT-500, HT-600, HT-755,
HT-828, HS-500 EM, HS-800 EM, Quiet Cube & Vecloader
(B) Part No. – FAB9507

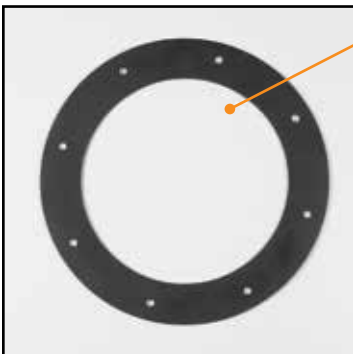

DUMP CHUTE GASKET
Fits: Hurricane HT-400,
HT-500, HT-600, HT-755, HT-828,
HS-500 EM, HS-800 EM, Quiet
Cube & Vecloader
Part No. – MC7655



WEAR PARTS & WEAR PLATES

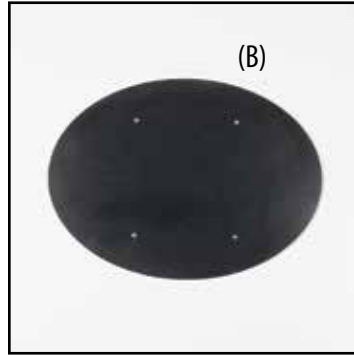
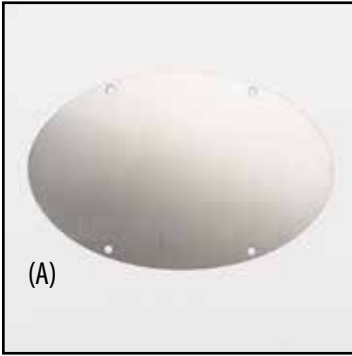

DUMP DOOR GASKET RETAINER PLATE

Fits: Hurricane HT-400, HT-500, HT-600, HT-755, HT-828, HS-500 EM, HS-800 EM, Quiet Cube & Vecloader

(A) Part No. – MC7007-1

DUMP DOOR GASKET

Fits: Hurricane HT-400, HT-500, HT-600, HT-755, HT-828, HS-500 EM, HS-800 EM, Quiet Cube & Vecloader

(B) Part No. – MC7007



BUTTERFLY COVER for 8" or 12" Butterfly Valve New Style (Shown)

Fits: Hurricane HT-500, HT-600, HT-755, HT-828, HS-500 EM & HS-800 EM

Part No. – FAB5160

BUTTERFLY COVER – Old Style, w/Mounting Feet

Fits: Hurricane HT-500, HT-600, HT-755, HT-828, HS-500 EM & HS-800 EM

Part No. – FAB5159

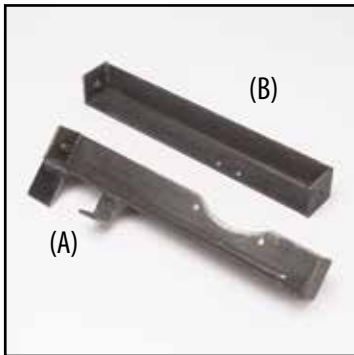

BUTTERFLY COVER SUPPORT BRACKET Air Cylinder Side

Fits: Hurricane HT-755, HT-828 & HS-800 EM

(A) Part No. – FAB5160-1

BUTTERFLY COVER SUPPORT BRACKET

Fits: Hurricane HT-755, HT-828 & HS-800 EM

(B) Part No. – FAB5160-2

BUTTERFLY COVER SUPPORT BRACKETS - Old Style, set of (2) both sides

Fits: Hurricane HT-755, HT-828 & HS-800 EM

Part No. – FAB5157



2" x 3" UPPER SUPPORT ARM (Shown)

Fits: Hurricane HT-500, HT-600, HT-755, HT-828 & Vecloader

Part No. – FAB0015

LOWER BAGHOUSE LIFT ARM Connects to Hydraulic Cylinder

Fits: Hurricane HT-500, HT-600, HT-755, HT-828 & Vecloader

Part No. – FAB0015-1

VERTICAL LIFT ARM Connects to Baghouse Pins

Part No. – FAB0015-2





JACK STANDS w/Lift Handle (Shown)

Fits: Hurricane HT-300, HT-500, HT-600, HT-755, HT-828 & Vecloader

Part No. – FAB0016

OUTER JACK STAND TUBE (Weld on)

Fits: Hurricane HT-500, HT-600, HT-755, HT-828 & Vecloader

Part No. – FAB0016-1



FRONT CRANK JACK STAND

Fits: Hurricane HT-500 & HT-600

Part No. – MC7014

HURRICANE FRONT CRANK JACK PASSENGER SIDE

Fits: Hurricane HT-755 & HT-828

Part No. – MC7014-6

HURRICANE FRONT CRANK JACK HANDLE

Part No. – MC7014-2

HURRICANE FRONT CRANK JACK DRIVER SIDE

Fits: Hurricane HT-755 & HT-828

Part No. – MC7014-7



FRONT CRANK JACK for Vecloaders

Fits: Vecloader

Part No. – MC7014-1

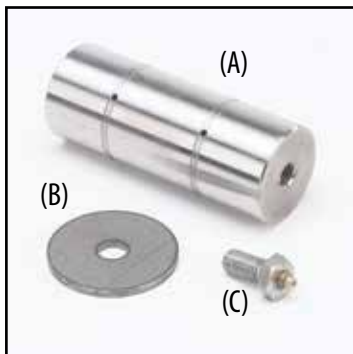

PIVOT PINS for Lifting Arms 2" OD x 5.125"

Fits: Hurricane HT-500, HT-600, HT-755, HT-828 & Vecloader

(A) Part No. – FAB0014

PIVOT PIN CAPS

Fits: Hurricane HT-500, HT-600, HT-755, HT-828 & Vecloader

(B) Part No. – FAB0014-1

PIVOT PIN BOLT w/Grease Fitting

Fits: Hurricane HT-500, HT-600, HT-755, HT-828 & Vecloader

(C) Part No. – FAB0014-2

PIVOT PINS for Towers 2" OD x 6.625"

Fits: Hurricane HT-500, HT-600, HT-755, HT-828 & Vecloader

Part No. – FAB0014-3



WEAR PARTS & WEAR PLATES



LOWER DEFLECTOR – 2-1/2' Piece

Fits: Hurricane HT-500, HT-600, HT-755, HT-828 & Vecloader

Part No. – FAB0004 \$95.30 each

STAINLESS STEEL LOWER DEFLECTOR – 2-1/2' Piece

Fits: Hurricane HT-500, HT-600, HT-755, HT-828 & Vecloader

Part No. – FAB0004-SS



LOWER WEAR PLATE for Under Inlet Part, Weld In

Fits: Hurricane HT-400, HT-500, HT-600, HT-755, HT-828, HT-500EM, HS-800EM & Quiet Cube Models

Part No. – FAB0004-1



UPPER DEFLECTORS for Hurricane 6" Inlet Pipe

Fits: Hurricane HT-500, HT-600, HS-500 EM & Quiet Cube

Part No. – FAB0018

STAINLESS STEEL UPPER DEFLECTOR for Hurricane 6" Inlet Pipe

Fits: Hurricane HT-500, HT-600, HS-500 EM & Quiet Cube

Part No. – FAB0018-SS

UPPER DEFLECTOR for Hurricane 755/828

Fits: Hurricane HT-755, HT-828 & HS-800 EM

Part No. – FAB0024

UPPER DEFLECTOR for 72" Diameter Cylinder

Fits: Hurricane HT-828

Part No. – FAB7201



INNER WEAR PLATES for all 6" Inlet Pipe Hurricanes

Including Part #FAB5164 – Fits: Hurricane HT-500, HT-600, HS-500 EM & Quiet Cube

Part No. – FAB5161

STAINLESS STEEL INNER WEAR PLATES for all 6" Inlet Pipe Hurricanes

Including Part #FAB5164 – Fits: Hurricane HT-500, HT-600, HS-500 EM & Quiet Cube

Part No. – FAB5161-SS

INNER WEAR PLATE

for Hurricane 755 & 828

Fits: Hurricane HT-755, HT-828 & HS-800 EM

Part No. – FAB0023

INNER WEAR PLATE for Hurricane 828 w/ 72" Diameter Cylinder (17" x 48.5")

Fits: Hurricane HT-828

Part No. – FAB7200

522 INNER WEAR PLATE

Fits: Vecloader 522

Part No. – FAB0003

INNER WEAR PLATE – Vecloader 624, 721 for

All Vector 6" Inlet Pipe Units

Part No. – FAB0005

INNER WEAR PLATE

for Hurricane 828 w/ 72" Diameter Cylinder (17" x 32") Fits: Hurricane HT-828

Part No. – FAB7200-1





INNER WEAR PLATE HARDWARE – Set of (4) Washers & (4) Screws & (4) Nuts
 Fits: Hurricane HT-500, HT-600, HT-755, HT-828, HS-500 EM, HS-800 EM & Quiet Cube
Part No. – FAB5164



REMOVABLE WEAR PLATE for All 6" Inlet Hurricanes
 Fits: Hurricane HT-500, HT-600, HS-500 EM, Quiet Cube, Vecloader 624, 721

Part No. – MC7020 \$322.15 each
REMOVABLE WEAR PLATE – Model 828 & Newer 755
 Fits: Hurricane HT-755, HT-828 & HS-800 EM
Part No. – MC7020-1 \$367.15 each

REMOVABLE WEAR PLATE – Vecloader 422/522
 Fits: Vecloader
Part No. – MC7008



HYDRAULIC SYSTEM PARTS

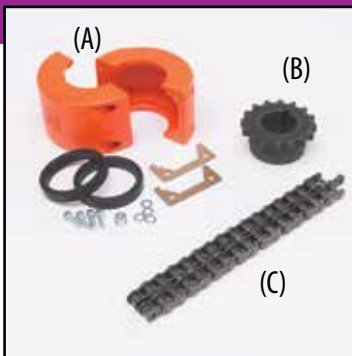

HYDRAULIC AUGER FLEX COUPLING COVER
 for Chain-Style Flex Coupling
 Fits: Hurricane HT-500, HT-600, HT-755 & HT-828

(A) Part No. – HY2001

HYDRAULIC AUGER COUPLING – 1/2" for
 Chain-Style Coupling of Auger Motor /Lower Auger Shaft
 Fits: Hurricane HT-500, HT-600, HT-755 & HT-828

(B) Part No. – HY2000

HYDRAULIC AUGER FLEX COUPLING CHAIN
 Fits: Hurricane HT-500, HT-600, HT-755 & HT-828
(C) Part No. – HY2002



HYDRAULIC SYSTEM PARTS



HYDRAULIC FLUID FILTER CARTRIDGE

Fits: Hurricane HT-400, HT-500, HT-600, HT-755, HT-828 & Vecloader

Part No. – HY3000



HYDRAULIC MOTOR for ASBESTOS AUGER older Hurricanes and Vecloader

Fits: Hurricane HT-555 & Vecloader

Part No. – HY3001

HYDRAULIC MOTOR for ASBESTOS AUGER on Hurricane Vacuum Loader Models 500, 600, 755 & 828

Serial #145 and higher

Fits: Hurricane HT-500, HT-600, HT-755 & HT-828

Part No. – HY3001-1



HYDRAULIC PUMP for Vecloaders

Fits: Vecloader

Part No. – HY3002



HYDRAULIC FLOW CONTROL (Silver)

Fits: Hurricane HT-500, HT-600, HT-755, HT-828 & Vecloader

Part No. – HY3003

HYDRAULIC FLOW CONTROL w/Restrictor (Gold)

Fits: Hurricane HT-500, HT-600, HT-755, HT-828 & Vecloader

Part No. – HY3003R

NEW STYLE VELOCITY FLOW CONTROL

Part No. - HY3003R-1



HYDRAULIC OVER CENTER VALVE

Fits: Hurricane HT-500, HT-600, HT-755, HT-828 & Vecloader

Part No. – HY4506





HYDRAULIC SOLENOID for Hurricane 500E, 600E & 755
 Fits: Hurricane HT-500, HT-600 & HT-755
Part No. – HY3007

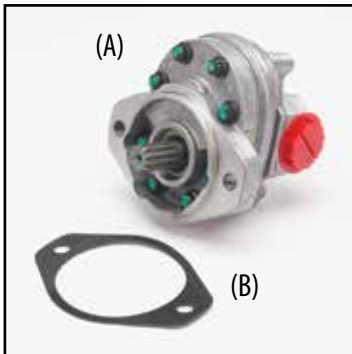

HYDRAULIC PUMP for Auxiliary Drive Engines
 Fits: Hurricane HT-400, HT-500, HT-600, HT-755 & HT-828
(A) Part No. – HY3008
GASKET – Between HYD Pump and Air Compressor
 Fits: Hurricane HT-400, HT-500, HT-600, HT-755 & HT-828
(B) Part No. – HY3008-1

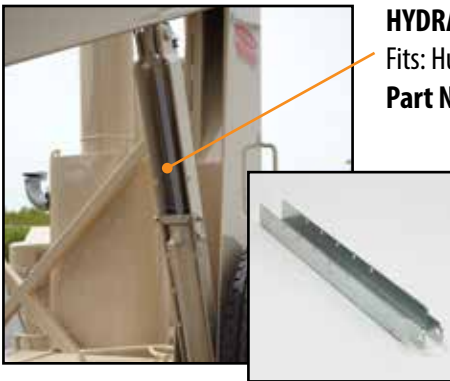

HYDRAULIC SAFETY STRUT
 Fits: Hurricane HT-400, HT-500, HT-600, HT-755 & HT-828
Part No. – HY3010



HYDRAULIC SAFETY STRUT MOUNTING PIN (Not Support Pin)
 Fits: All Trailer Mounted Hurricane 2008 or Newer
Part No. – HY3011



SAFETY STRUT SUPPORT PIN ASSEMBLY
 Fits: Hurricane HT-400, HT-500, HT-600, HT-755 & HT-828 2008 or Newer
Part No. – HY3012



HYDRAULIC SYSTEM PARTS



HYDRAULIC CYLINDER TRAILER LIFT

Fits: Hurricane HT-500, HT-600, HT-755, HT-828 & Vecloder
Part No. – HY3006



DOUBLE LEVER SPOOL VALVE

Shown
 Fits: Hurricane HT-500, HT-600, HT-755 & HT-828

Part No. – HY4001

NEW STYLE DOUBLE LEVER SPOOL VALVE WITH MANIFOLD

*Confirm vacuum model when ordering
Part No. - HY5100

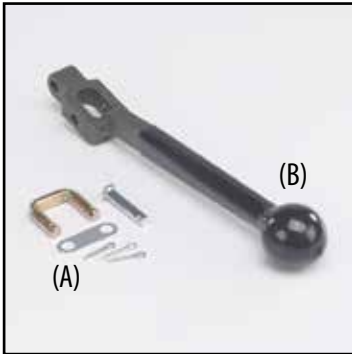

LINKAGE KIT

for Part # HY3014 Fits: Vecloder

(A) Part No. – HY3013

HYDRAULIC LEVER

Gresen Valve Fits: Vecloder

(B) Part No. – HY3014



SINGLE LEVER SPOOL VALVE

Fits: Hurricane HT-500, HT-600, HT-755 & HT-828

Part No. – HY4000



HYDRAULIC TANK INLET CAP

Fits: Hurricane HT-400, HT-500, HT-600, HT-755 & HT-828

Part No. – HY2004



HYDRAULIC LEVER

Fits: Hurricane HT-400, HT-500, HT-600, HT-755 & HT-828

(A) Part No. – HY3015

RUBBER BOOT For HY4000

(B) Part No. – HY4000-2

CAP BASE For HY4000

(C) Part No. – HY4000-1



HYDRAULIC SOLENOID for Asbestos Auger

Fits: Hurricane HT-500, HT-600, HT-755 & Vecloder

Part No. – HY3040

PLASTIC NUT for HY3040

Part No. – HY3040-1



HURRICANE 500/600 FRONT HYDRAULIC FOOT HYDRAULIC LINES

Part No. – HY3100

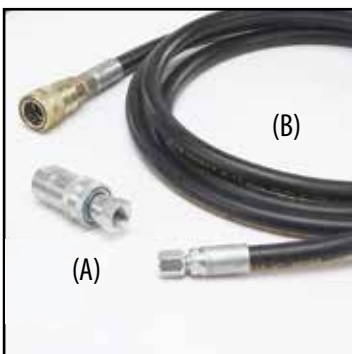

HYDRAULIC HOSE QUICK COUPLERS for the Cone w/Auger

Fits: Hurricane HT-500, HT-600, HT-755 & Vecloder

(A) Part No. – HY3090-1

HYDRAULIC LINE for Asbestos Auger/Tower to Cone

Fits: Hurricane HT-500, HT-600, HT-755 & Vecloder

(B) Part No. – HY3019



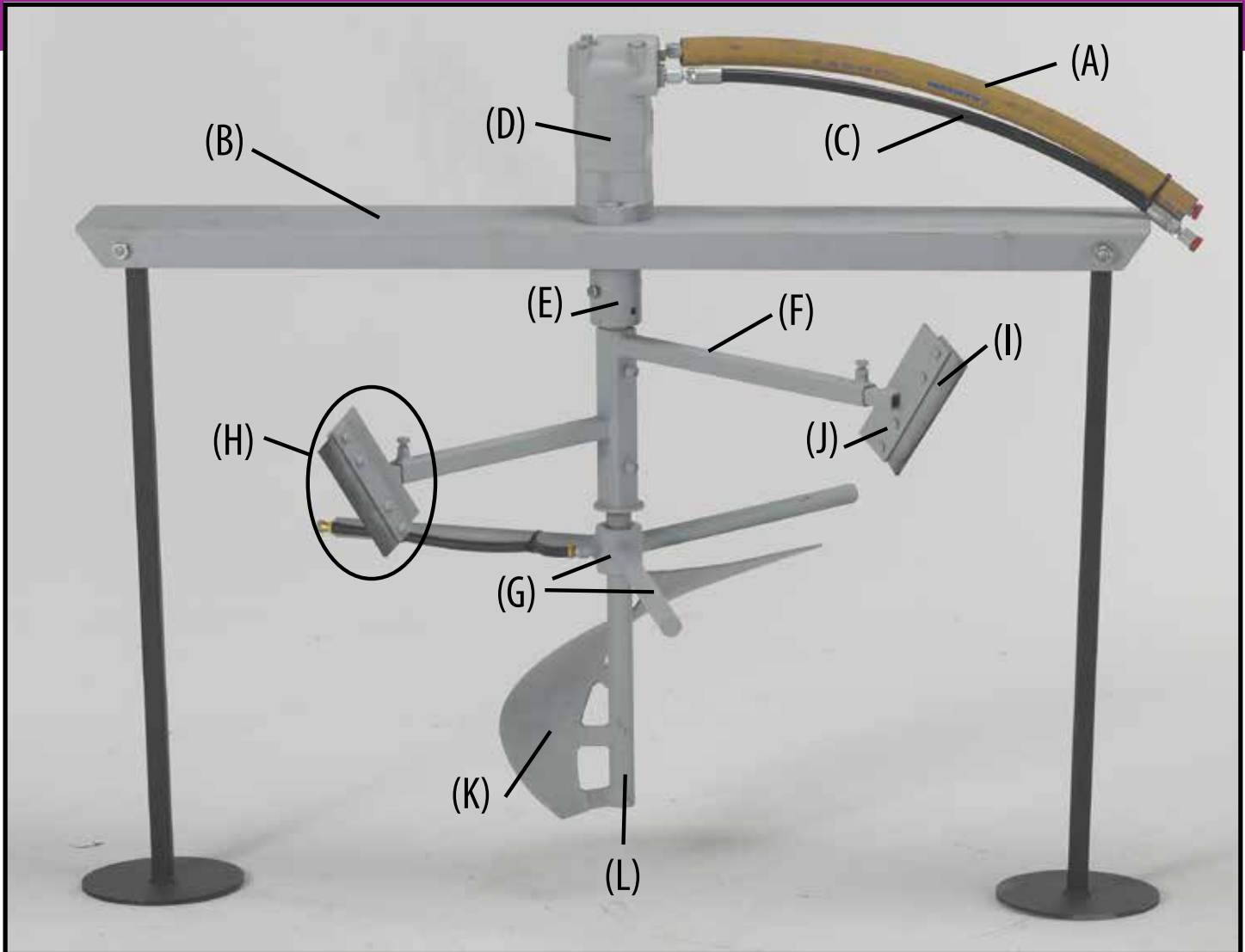

HYDRAULIC AUGER ASSEMBLY

Fits: Hurricane HT-500, HT-600, HT-755, HT-828 & HS-500 EM

Part No. – HY3087 \$3,975.00 each

Fits Hurricane Vacuums Only

INDIVIDUAL AUGER ASSEMBLY PARTS

AUGER HYDRAULIC LINE HOSE COVER

(A) Part No. – HY3093

AUGER MOUNTING CHANNEL

(B) Part No. – HY3089

HYDRAULIC LINE, CONE TO AUGER

(C) Part No. – HY3090

**HYDRAULIC MOTER FOR ASBESTOS
AUGER**

(D) Part No. – HY3001-1

AUGER MACHINED BUSHING

(E) Part No. – HY3088

AUGER PADDLE ARM ASSEMBLY

(F) Part No. – HY3097

AUGER STABILIZER ASSEMBLY

(G) Part No. – HY3099

**AUGER STABILIZER
ASSEMBLY BUSHING ONLY**

Part No. – HY3099-1

AUGER PADDLE ARM

(Arm + bolts)

(H) Part No. – HY3095

AUGER RUBBER WIPER

(I) Part No. – HY3095-1

AUGER PADDLE BACKING PLATE

(J) Part No. – HY3095-2

AUGER FLIGHT ONLY

(K) Part No. – HY3094

AUGER FLIGHT ASSEMBLY

(L) Part No. – HY3094-1



HYDRAULIC SYSTEM PARTS

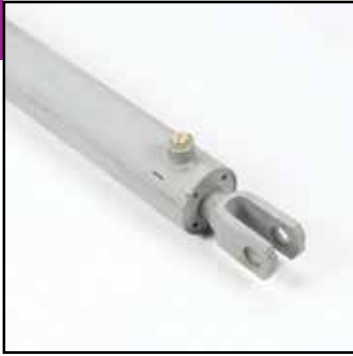

HYDRAULIC CYLINDER HOPPER LIFT

Fits: Hurricane HT-400, HT-500, HT-600, HT-755 & HT-828

Part No. – HY3091



HYDRAULIC FILTER GAUGE

Fits: Hurricane HT-400, HT-500, HT-600, HT-755, HT-828 & Vecloader

Part No. – HY3098

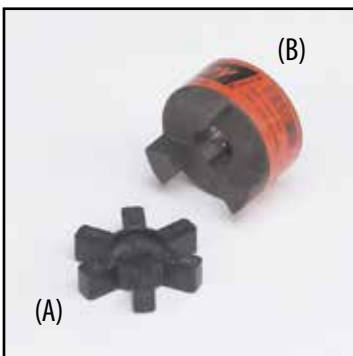

LOVE JOY COUPLING – 3/4" Engine

Fits: Vecloader 422/522

(A) Part No. – HY3400

LOVE JOY INSERT

Fits: Vecloader 422/522

(B) Part No. – HY3410



LOVE JOY COUPLING – 7/16" for Hydraulic Pump

Fits: Vecloader 422/522

Part No. – HY3420

LOVE JOY COUPLING – 1/2" for Hydraulic Pump

Fits: Vecloader 422/522

Part No. – HY3421



LEVEL GAUGE for Hurricane Hydraulic Tank

Fits: Hurricane HT-400, HT-500, HT-600, HT-755 & HT-828

Part No. – HY3500



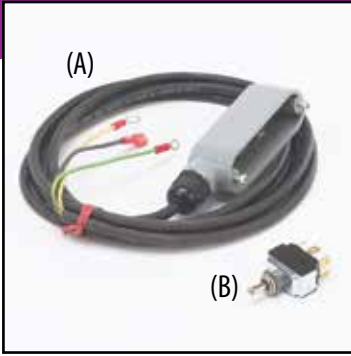

HYDRAULIC SWITCH ASSEMBLY to Raise & Lower Hopper

Fits: Hurricane HT-500, HT-600 & HT-755

(A) Part No. – HY4100

HYDRAULIC SWITCH to Raise & Lower Hopper – Switch Only (No Box or Cable)

Fits: Hurricane HT-500, HT-600 & HT-755

(B) Part No. – HY4101

HYDRAULIC POWER PACK ASSEMBLY (All Parts Assembled)

Fits: Hurricane HT-500 & HT-600 w/12V Hydraulics

Part No. – HY4500

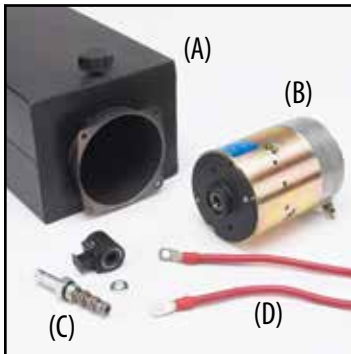

HYDRAULIC TANK for Hydraulic Power Pack

(Replaces Tank That Comes w/Power Pack – Larger Volume) Used on 500/600 & 755 w/Electric Hydraulics

Fits: Hurricane HT-500, HT-600 & HT-755

(A) Part No. – HY4501

ELECTRIC MOTOR for Hydraulic Power Pack

Fits: Hurricane HT-500, HT-600 & HT-755

(B) Part No. – HY4503

HYDRAULIC SOLENOID for Hydraulic Power Pack –

Controls Flow Direction

Fits: Hurricane HT-500, HT-600 & HT-755

(C) Part No. – HY4504

POWER CABLE for Hydraulic Power Pack

Fits: Hurricane HT-500, HT-600 & HT-755

(D) Part No. – HY4502



MISCELLANEOUS PARTS



Bulk Bag
Fits: All



Dust Sleeve
Fits: All

BULK BAG – 6.5oz Polypropylene

4' x 4' x 4' w/Flat Bottom, 22" Spout & H.D. Lifting Straps

Part No. – MC1224-2

WASTE BLADDER BAGS – 20-Yard w/Two Spouts

Part No. – MC1224

BULK BAG – 4' x 4' x 4' w/6 Mil Liner & 22" Spout

Part No. – MC1224-4

DUST SLEEVE KIT

Fits: All

Part No. – MC1223 \$368.40 each

FILTERING BAG for 500LQ – 60" x 60" x 60" 8 oz. cloth

Part No. – LQ1000 \$242.95 each



MISCELLANEOUS PARTS



DUMP DOOR STRAP KIT

Fits: Hurricane HT-400, HT-500, HT-600, HT-755 & HT-828

Part No. – MC7007-4

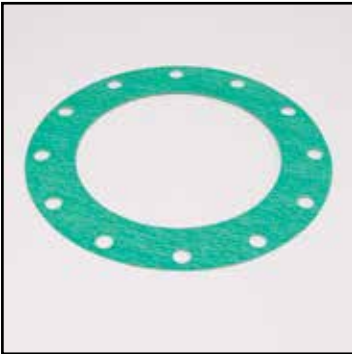

14" I.D. BLOWER GASKET For Hurricane 828 (1021DVJ) Air Intake & Discharge Silencer Ports

Part No. – MC4100

12" I.D. BLOWER GASKET

For All Ports on (721DVJ) HT-755 + Top Intake Silencer on (1021DVJ) HT-828

Part No. – MC4101

10" I.D. BLOWER GASKET For Hurricane 500

(616DVJ) Exhaust Silencer + HT-600 (624) Intake Port

Part No. – MC4102

8" I.D. BLOWER GASKET For Hurricane 500

(616DVJ) Intake Port, Top Intake Silencer Port + HT-600 Exhaust Port

Part No. – MC4103

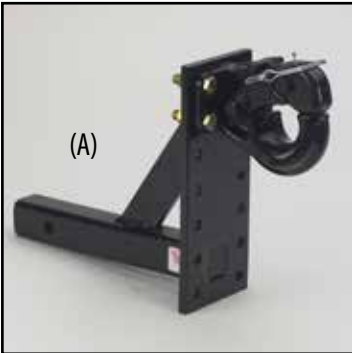

(A)



(B)

(C)

PINTLE HITCH ASSEMBLY (ALL PARTS SHOWN)

(A) Part No. – MC6027

TOW RING, 4-BOLT, 2.5" ID

(B) Part No. – MC6028

BOLT KIT FOR TOW RING

(C) Part No. – MC6028-1



(A)

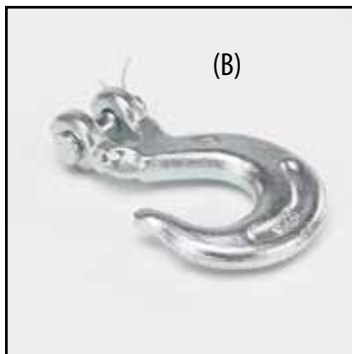

(B)

SYNTHETIC BLOWER OIL – 1gal for Roots Blowers

Fits: Hurricane HT-400, HT-500, HT-600, HT-755, HT-828 & Vecloader

(A) Part No. – MC6800

1/2" SAFETY CHAIN HOOKS

Fits: Hurricane HT-400, HT-500, HT-600, HT-755, HT-828 & Vecloader

(B) Part No. – MC1226

3/8" SAFETY CHAIN HOOKS

Fits: Hurricane HT-300, HT-500EL, HT-500 & HT-600

(B) Part No. – MC1228

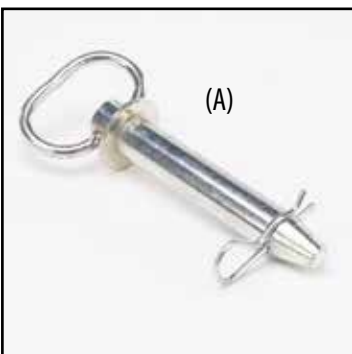

(A)



(B)

BAGHOUSE PINS for 500EM/800EM – 1" x 4.5" Pin & Clip

Fits: Hurricane HS-500 EM & HS-800 EM

(A) Part No. – MC6001

BUTTERFLY SPRINGS

Fits: Hurricane HT-400, HT-500, HT-600, HT-755, HT-828 & Vecloader

(B) Part No. – MC7001





JACK PIN – 1/2" x 4-1/2"
 Fits: Hurricane HT-400, HT-500, HT-600,
 HT-755, HT-828 & Vecloader
Part No. – MC7003



1" SAFETY STRUT PINS
 Fits: Hurricane HT-400, HT-500, HT-600,
 HT-755, HT-828 & Vecloader
Part No. – MC7002



LINCH PINS for MC7002
 Fits: Hurricane HT-400, HT-500, HT-600,
 HT-755, HT-828 & Vecloader
Part No. – MC7004



10" MANHOLE
 Fits: All Hurricane Models
Part No. – MC7017



16" MANHOLE
 Fits: Hurricane HT-500, HT-600,
 HT-755, HT-828 & Vecloader
Part No. – MC7006

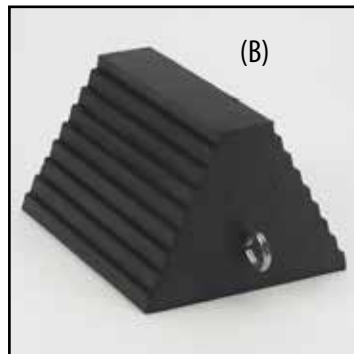
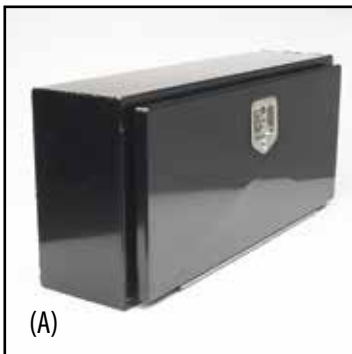

LOCKING TOOL BOX – Fender Mount
 Fits: All
(A) Part No. – MC7009

WHEEL CHOCK
 Fits: All
(B) Part No. – MC9575

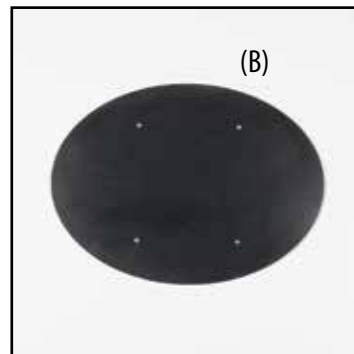
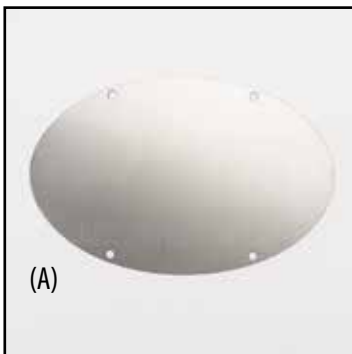

DUMP DOOR GASKET RETAINER PLATE
 Fits: Hurricane HT-400, HT-500, HT-600, HT-755, HT-828, HS-500 EM,
 HS-800 EM, Quiet Cube & Vecloader

(A) Part No. – MC7007-1

DUMP DOOR GASKET

Fits: Hurricane HT-400, HT-500, HT-600,
 HT-755, HT-828, HS-500 EM, HS-800 EM,
 Quiet Cube & Vecloader

(B) Part No. – MC7007



MISCELLANEOUS PARTS

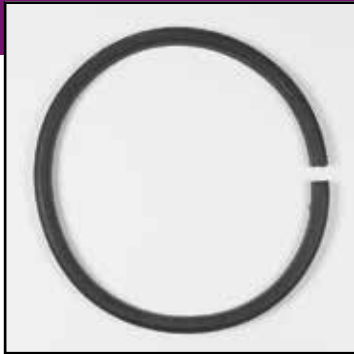

MANHOLE GASKET for 16" Manholes w/4 Clamps

Fits: All

Part No. – MC7013-1



10" MANHOLE GASKET

Fits: HT-400, HT-500, HT-600, HT-755,
HT-828, HS-500 EM & HS-800 EM

Part No. – MC7013-2



**10" MANHOLE STAINLESS
STEEL RETAINER PLATE**

Fits: HT-400, HT-500, HT-600,
HT-755, HT-828, HS-500 EM &
HS-800 EM

Part No. – FAB30666



GASKET for Blower Safety Filter Lid for Old Style Hurricane 755/828 w/Single Blower Safety Filter

Fits: HT-755 & HT-828

Part No. – MC7012

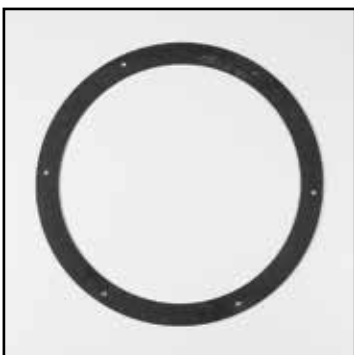

GASKET for Blower Safety Filter Lid - Hurricanes

Fits: HT-400, HT-500, HT-600, HS-500 EM & QC-150

Part No. – MC7011

GASKET for Blower Safety Filter Lid - Vecloader

Fits: Vecloader 522, 624 & 721

Part No. – MC7011-1

GASKET for Horizontal Blower Safety Filter Gasket, 17"

Fits: Hurricane HT-500 & HT-600

Part No. – MC7011-2

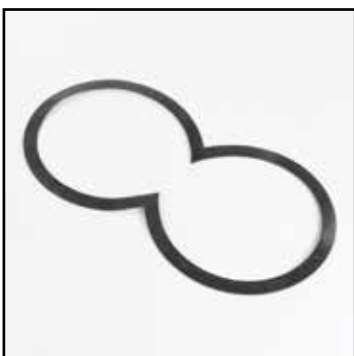

TWIN BLOWER SAFETY FILTER GASKET

Fits: Hurricane HT-755, HT-828 & HS-800 EM

Part No. – MC7700



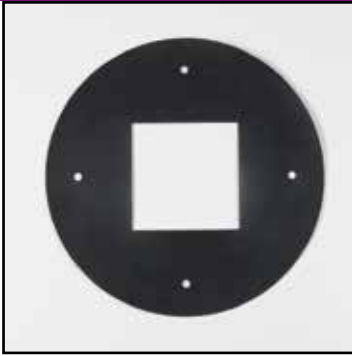

16" MANHOLE GASKET

Fits: All

Part No. – MC7013



PNEUMATIC ACTUATED DUMP VALVE w/Bag Clamp & Water Wash Down System

Fits: All

Part No. – MC7015



BAG CLAMP BRACKET for MC7015

Fits: All

Part No. – MC7015-1

BAG CLAMP ASSEMBLY for Pneumatic Dump Valve MC7015 (Shown)

Fits: All

Part No. – MC7015-2



SHORT REACH DOOR LATCH for John Deere Engine (All Hurricanes Except 555 & 655)

Fits: Hurricane HT-500, HT-600, HT-755 & HT-828

Part No. – MC7019

LONG REACH DOOR LATCH for John Deere Engine

Fits: Hurricane HT-500EL, HT-600, HT-755 & HT-828

Part No. – MC7019-1



DOOR LATCH (NEW STYLE)

Fits: HT-755 & HT-828

Part No. – MC7019-3



MISCELLANEOUS PARTS



VALVE ROLLER REPAIR KIT

Fits: Vecloader

Part No. – MC7042



LOCKING FUEL CAP

Fits: Hurricane HT-400, HT-500, HT-600, HT-755, HT-828 & Vecloader

Part No. – MC7050



DOOR LATCHES for Older Vecloaders

Fits: Vecloader

Part No. – MC7300



25' GROUNDING REEL

Fits: All

Part No. – MC8981

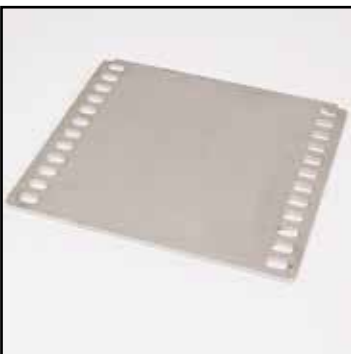

SLIDE GATE REPLACEMENT PLATE

Fits: Vecloader

Part No. – MC7701





EXHAUST SILENCER RAINCAP for Hurricane 500/600

Fits: Hurricane HT-500 & HT-600

Part No. – MC7898

RAIN CAP for Silencer

Fits: Hurricane HT-755, HT-828

Part No. – MC1210



EXHAUST SILENCER COUPLER KIT for Hurricane 500/600

Fits: Hurricane HT-500 & HT-600

Part No. – MC7899



HURRICANE WHEEL BEARING CAPS

Fits: Hurricane HT-400, HT-500 & HT-600

Part No. – MC8000



HURRICANE WHEEL OIL CAP for Hurricane 755/828

Fits: Hurricane HT-755 & HT-828

Part No. – MC7999



HURRICANE WHEEL BEARING CAP WITH RUBBER GROMMET

Fits: Hurricane HT-500EL, HT-500 & HT-600

Part No. – MC8000-1

HURRICANE WHEEL BEARING CAP WITH RUBBER GROMMET

Fits: Hurricane HT-755 & HT-828

Part No. – MC7999-1



MISCELLANEOUS PARTS

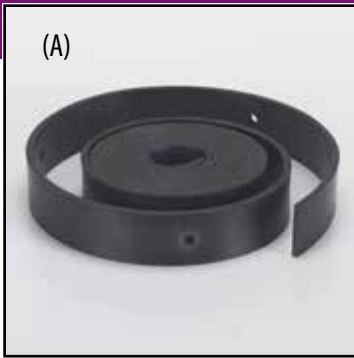

BAGHOUSE DOME GASKET – Cone to Cylinder Gasket

Fits: Hurricane HT-500, HT-600, HT-755, HT-828, HS-500 EM, HS-800 EM & Vecloader

(A) Part No. – MC9282

NEW STYLE BOLTLESS DOME GASKET for 2014 or Newer Hurricane with the Boltless Dome on Baghouse

(B) Part No. – MC9284



VENT PLUGS for Roots Blower (616DVJ, 624)

Fits: Hurricane HT-500, HT-600, HS-500 EM & Vecloader

(A) Part No. – MC9309

VENT PLUGS for Roots Blower (721)

Fits: Hurricane HT-755

(A) Part No. – MC9309-1

SIGHT GLASSES for Roots Blower

Fits: Hurricane HT-400, HT-500, HT-600, HS-500 EM & Vecloader

(B) Part No. – MC9308

HURRICANE 828/800 BLOWER SIGHT GLASS

Fits: Hurricane HT-828 & HS-800 EM

(B) Part No. – MC9318

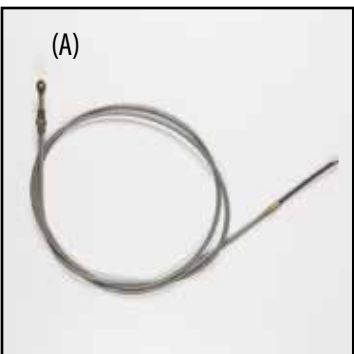

PARKING BRAKE CABLE

Fits: Vecloader

(A) Part No. – MC9613

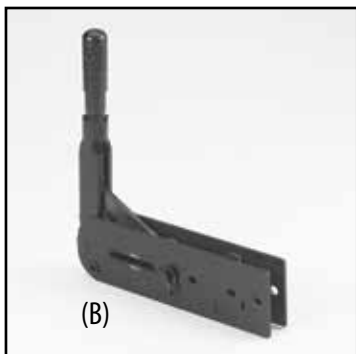

PARKING BRAKE LEVER

Fits: Vecloader

(B) Part No. – MC9613-1



6" RELIEF VALVE NEW STYLE

(A) Part No. – MC9706-1

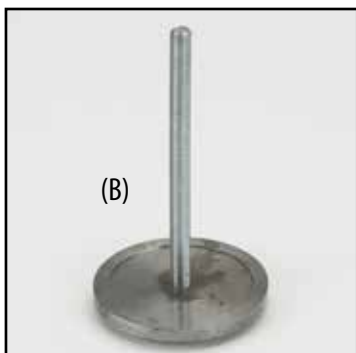

RELIEF VALVE DISK & 1/2" THREADED ROD

Fits: Newer HT-600

(B) Part No. – RV1007

6" RELIEF VALVE ASSEMBLY OLD STYLE

Fits: Hurricane HT-600 & Vecloader

Part No. – MC9706

4" RELIEF VALVE ASSEMBLY

Fits: Hurricane HT-300

Part No. – RV1004





6" RELIEF VALVE SPRING

Fits: Hurricane HT-600 & Vecloader

(A) Part No. – RV2000

RELIEF VALVE BUSHING

Fits: Hurricane HT-600 & Vecloader

(B) Part No. – RV1001

RELIEF VALVE DISK

Fits: Hurricane HT-600 & Vecloader

(C) Part No. – RV1000



SAFETY DECAL KIT

Fits: Hurricane HT-400, HT-500, HT-600, HT-755 & HT-828

Part No. – MC9711

SAFETY STICKER BANDING KIT (Not shown)

Part No. - MC9711-1



8" BUTTERFLY VALVE DISK

Fits: Hurricane HT-400, HT-500, HT-600 & Vecloader

Part No. – MC9713

12" BUTTERFLY VALVE DISK

Fits: Hurricane HT-755, HT-828 & Vecloader 622

Part No. – MC9003

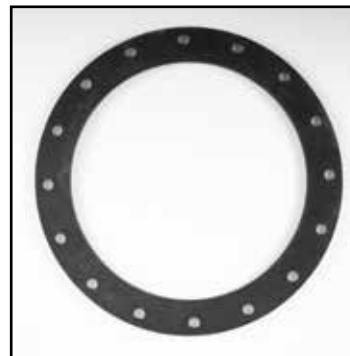

8" BUTTERFLY VALVE GASKET

for between valve and flange
Fits: Hurricane HT-400, HT-500, HT-600 & HS-500 EM

Part No. – MC9714-1



8" BUTTERFLY VALVE

Fits: Hurricane HT-400, HT-500, HT-600 & Vecloader

Part No. – MC9714

12" BUTTERFLY VALVE – Complete

Fits: Hurricane HT-755, HT-828 & Vecloader

Part No. – MC1200



8" SURE SEAL VALVE Fits: All

Part No. – MC9716

DRUMMING VALVE

For Hurricane with 8" Sure Seal

Part No. – MC9720



8" BAG CLAMP ASSEMBLY for 8" Butterfly Dump Valves (MC9716-2)

Part No. – FAB5003



MISCELLANEOUS PARTS



TOP HAT 55 GAL. DRUM FILLER – Extra heavy duty w/handles
Part No. – FAB9897

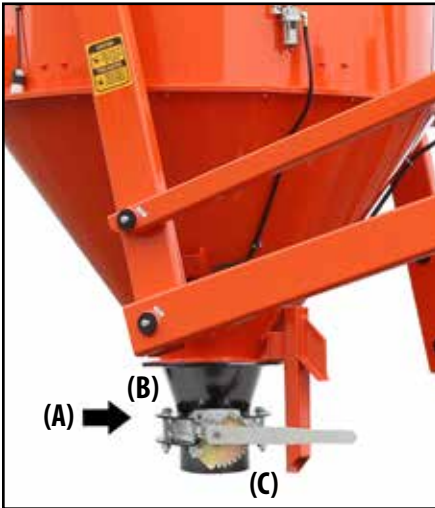

8" SURE SEAL VALVE to Vacuum Cone, Includes: 12" Flange to 8" Flange Reducer Cone (FAB5001)
8" Valve (MC9716) Handle (MC9716-1) 2-8" Flanges, Welded & Assembled
(A)Part No. – MC9716-2

CONE to DUMP VALVE –12" x 8" with 12" Dump Door Flange and 8" Sure Seal Flange on Bottom
Fits: Hurricane HT-500, HT-600, HT-755, HT-828 & Vecloder
(B)Part No. – FAB5001

BOTTOM FLANGE for MC9716-2 with 8" OD Nipple
Fits: Hurricane HT-500, HT-600, HT-755, HT-828 & Vecloder
(C)Part No. – FAB5002



DRUMMING VALVE FOR HURRICANE
with 8" Sure Seal
Part No. – MC9720



2 YARD SELF DUMPING HOPPER
with 6" Inlet and Outlet
Part No. – HC6723





AUGER BEARING For Tail End of Upper and Lower Augers (opposite of motor end)

Part No. – DCP0004-1

AUGER BEARING For Motor End of Upper and Lower Auger (1.5" Bore)

Part No. – DCP0004

AUGER STUB SHAFT 9" LONG

Part No. – DCP0032

AUGER DRIVE SHAFT WITH KEY WAY 12-3/8" LONG

Part No. – DCP0033

HYD SPOOL VALVE DETENT KIT

Part No. – DCP3011

SPROCKET 17 TOOTH For Upper and Lower Auger Drive 1.5" Bore

Part No. – DCP1020

4 BOLT BEARING GASKET SEAL

Part No. – DCP0036

20,000 CFM DIESEL DUST COLLECTOR BEARING COVER GUARD

Part No. – DCP0046

AUGER DRIVE COUPLER For Direct Drive Augers

Part No. – DCP0054

HYDRAULIC MOTOR For Augers

Part No. – DCP1018

4" DIAMETER UHMV DISK For 20,000 CFM Auger

Part No. – DCP0036-7

4 BOLT PLATE SEAL 1/2" THICK WITH GREASE SEAL INSTALLED

Part No. – DCP0036-1





12 VOLT SOLENOID For Dust Collectors and Hurricane 300 with Matrix Wiring

Part No. – DCP0015-3

120 VAC REPLACEMENT COIL For Integral Solenoid 1# Diaphragms

Part No. – DCP0057

INTEGRAL POLE ASSEMBLY With Top Cover (Cover W/Pole)

Part No. – DCP0029

DIAPHRAGM REBUILD KIT For DCP0020 And DCP0026, For IVEC 20,000 Diesel Duct Collectors

Part No. – DCP0027

FORM A DIN TO M12 MALE 2M BLACK PUR CABLE 12 VDC

Part No. – DCP3020

MURR-EL M12 MALE 0 DEG/MSUD VALVE PLUG, 120 VAC

Part No. – DCP95151

MURR-EL M12 PORT PLUG PLASTIC

Part No. – DCP3024

120 VAC, M12 CABLE With Dinn Connector with 2 Meter Cable

Part No. – DCP3023

ARCTIC AIR DRYER KIT For Diesel Powered Dust Collectors and Vacuums with Alcohol Kit

Part No. – DCP1001

ARCTIC AIR DRYER (2) CARTRIDGES

Part No. – DCP1001-1

FORM A DIN TO M12 MALE 3M BLACK PUR CABLE, 12 VDC

Part No. – DCP3021

DIAPHRAGM For 20,000 CFM IVEC Diesel Dust Collector after Serial Number DCT20033

Part No. – DCP0026

ARCTIC AIR DRYER COMPLETE REBUILD KIT, CHECK VALVES, PURGE VALVES INLET CHECK VALVES AND 2 CARTRIDGES

Part No. – DCP1001-2

12 VOLT VIBRATOR For 20,000 CFM Dust Collectors

Part No. – DCP2001

120 VAC MURR JUNCTION BLOCK 8 STATION

Part No. – DCP3022

MURR 8 POINT CONNECTOR, 12 VDC

Part No. – DCP3019

1 LITER OF VMAC HIGH PERFORMANCE SYNTHETIC OIL

Part No. – DCP0021

MURR DINN CABLE, M12 CONNECTOR, 1 METER 120 VAC

Part No. – DCP3025

VMAC 500 HOUR SERVICE KIT ** For 4.5 Liter Cummins And 4.5 Liter John Deere with Belt Driven Air Compressors**Material Number 10263553

Part No. – DCP0050

VMAC 1000 HOUR SERVICE KIT For 4.5 Liter Cummins with Belt Drive Air Compressor

Part No. – DCP0060

ARCTIC AIR DRYER EXHAUST MUFFLER

Part No. – DCP1001-3

VMAC CONTROLLER For 4.5l Air Compressor

Part No. – DCP1021-2

VMAC BELT For 4.5 Liter 110 hp Cummins Engine

Part No. – DCP0051





4 GROOVE SINGLE BANDED DRIVE BELT For High Static 20,000 CFM Dust Collectors

Part No. – DCP0019-4

12,000/20,000/ 45,000 CFM DIESEL TIER 4 (65/74/134HP KOHLER) FUEL FILTER/WATER SEPARATOR

Part No. – DCP2044

12,000 /20,000/45,000 CFM DIESEL TIER 4 ENGINE (65/74/134 HP KOHLER) OIL FILTER

Part No. – DCP2045

V-BELT DRIVE: V -GROOVE IDLER TENSIONER PULLEY (BEARING ONLY)

Part No. – DCP1010

FLAT IDLER UPGRADE KIT For Fan

Part No. – DCP1900

FLAT IDLER UPGRADE KIT For Slide Plate, Fits 6,000, 12,000 and 20,000 CFM Diesel Dust Collectors Replaces DCP1011

Part No. – DCP1901

DRIVE BELT For 6000 CFM Diesel Dust Collector

Part No. – DCP6000

2,000/20,000/45,000 CFM DIESEL DUST COLLECTOR (65/74/134 HP KOHLER) LARGE ENGINE AIR FILTER.

Part No. – DCP2046

5VX1600 For 40 DC Electric Requires 5

Part No. – DCP4005

ENTIRE CLUTCH For 20,000 Diesel Dust Collector, (All Models, High Static or Standard Cummins or John Deere) Including Pilot Bearing

Part No. – DCP0008

PTO/CLUTCH For 12,000 Diesel Dust Collector with Tier 4 Kohler Engine

Part No. – DCP9000K

PTO/CLUTCH For 20,000 Diesel Dust Collector with Tier 4 Kohler Engine

Part No. – DCP9001K

PTO/CLUTCH For 45,000 Diesel Dust Collector with Tier 4 Kohler Engine

Part No. – DCP9002K

INTERNAL CLUTCH ASSEMBLY For 12,000 Diesel Dust Collector with Tier 4 Kohler Engine

Part No. – DCP9000K-1

INTERNAL CLUTCH ASSEMBLY For 20,000 Diesel Dust Collector with Tier 4 Kohler Engine

Part No. – DCP9001K-1

INTERNAL CLUTCH ASSEMBLY For 45,000 Diesel Dust Collector with Tier 4 Kohler Engine

Part No. – DCP9002K-1





PILOT BEARING For 12,000 & 20,000 Diesel Dust Collector with Tier 4 Kohler Engine

Part No. – DCP9000K-2

PILOT BEARING For 45,000 Diesel Dust Collector with Tier 4 Kohler Engine

Part No. – DCP9002K-2

DRIVE RING For 12,000 Diesel Dust Collector with Tier 4 Kohler Engine

Part No. – DCP9000K-3

DRIVE RING For 20,000 Diesel Dust Collector with Tier 4 Kohler Engine

Part No. – DCP9001K-3

DRIVE RING For 45,000 Diesel Dust Collector with Tier 4 Kohler Engine

Part No. – DCP9002K-3

MURR-EL EXACT 128X M12 4POLE MOLDED CABLE, 120 VAC

Part No. – DCP95150

MURR-EL M12 MALE 0 DEG/MSUD VALVE PLUG, 120 VAC

Part No. – DCP95151

12,000/20,000/45,000 CFM DIESEL POWERED DUST COLLECTOR (65/74/134 HP KOHLER) INNER AIR CLEANER

Part No. – DCP2047

DRIVE BELT For 45 DC Diesel (2 Required) 3 Groove

Part No. – DCP4500

ENGINE PULLEY (SHEEVE) For High Static Dust Collectors

Part No. – DCP0067

40/45 DC DIESEL DUST COLLECTOR PULLEY KIT

Part No. – DCP4501

FAN DRIVE BELT For IVEC 20,000 CFM Diesel Dust Collector

Part No. – DCP2000

DRIVE BELT For Fan on 20,000 CFM Diesel Dust Collector with High Static Fan

Part No. – DCP0019

BUSHING For Engine Pulley on High Static 20,000 CFM Dust Collectors (2.25”)

Part No. – DCP0067-1

DRIVE BELT For 12,000 CFM Diesel Dust Collector

Part No. – DCP0053

FAN BELT For 45,000 CFM Diesel DC with Kohler Engine (2 Required)

Part No. – DCP4004

ENGINE WATER SEPARATOR 24 HP KOHLER ENGINE

Part No. – DCP6010

ENGINE OIL FILTER 24 HP KOHLER

Part No. – DCP6011

PRIMARY AIR FILTER ELEMENT

For 24 HP Kohler Engine

Part No. – DCP6012





DOOR LATCH For Diesel Dust Collectors
Part No. – DCP1003

EXTERNAL DOOR LIFT OFF HINGE, RIGHT HAND 180 DEGREE
Part No. – DCP2005

EXTERNAL DOOR LIFT OFF HINGE LEFT HAND
Part No. – DCP2006

1" X 6" T HANDLE HITCH PIN
Part No. – DCP18501

1-1/4" X 7" T HANDLE HITCH PIN
Part No. – DCP18502

WELD ON STAINLESS STEEL DOOR HINGE For Diesel Dust Collectors
Part No. – DCP1013

DOOR LATCH ASSEMBLY For Electric Dust Collector Doors Same as (MC0889)

Part No. – DCP3015

10" STAINLESS STEEL SLIDE PLATE For Electric Dust Collectors (New 7 Gauge) Part DCP3101 Required to Replace on Pre 2022 Models

Part No. – DCP3100



DRUM TOP VAC

TURN A 55-GALLON DRUM INTO THE BEST VACUUM YOU'LL EVER OWN.

FOR OVER 25 YEARS THE VACTAGON DRUM TOP VACUUM FROM INDUSTRIAL VACUUM HAS SET THE STANDARD FOR POWER, DURABILITY, CONVENIENCE AND EFFECTIVENESS.

USER-FRIENDLY & ADAPTABLE

THE VACTAGON DRUM TOP VACUUM HAS BEEN USED FOR LEAD PAINT REMOVAL ON THE CAPITOL BUILDING IN WASHINGTON, THE BROOKLYN BRIDGE, BY NASA, UTILITIES INCLUDING TVA, THE MILITARY AND PRIVATE INDUSTRY FOR ALL TYPES OF PLANT MAINTENANCE.

EXCLUSIVE FILTRATION

A TWO STAGE, CARTRIDGE FILTER SYSTEM DESIGN THAT IS EASILY CLEANED OR CHANGED TO PROTECT THE FINAL HEPA FILTERING STAGE FOR MAXIMUM VACUUM POWER WITH SIMPLE MAINTENANCE.

EACH HEPA FILTER IS INDIVIDUALLY TESTED AND RATED AT 99.997% EFFICIENCY AT 0.3 MICRONS AND MEET OR EXCEED OSHA AND CLEAN AIR ACT STANDARDS.

IDEAL FOR ASBESTOS, LEAD OR OTHER SENSITIVE MATERIAL CLEAN UP.

ELECTRIC MODELS AVAILABLE IN SINGLE, TWIN OR QUAD CONFIGURATIONS.

PNEUMATIC MODELS AVAILABLE IN SINGLE OR DOUBLE CONFIGURATIONS.

WET OR DRY OPERATION STANDARD.



ELECTRIC MODELS

ITEM ID	POWER	AIR FLOW	INCHES OF Hg	FILTRATION	HOSE DIAM.
DT55	110v -120v, 9 AMP	106 CFM	6.5"	STD	1.5" OR 2"
DT55H	110v -120v, 9 AMP	106 CFM	6.5"	HEPA	1.5" OR 2"
DT255	110v -120v, 16 AMP	211 CFM	6.5"	STD	1.5" OR 2"
DT255H	110v -120v, 16 AMP	211 CFM	6.5"	HEPA	1.5" OR 2"
DT455	110v -120v, 16 AMP 220v -240v, 16 AMP	400 CFM	6.5"	STD	2" OR 3"
DT455H	110v -120v, 16 AMP 220v -240v, 16 AMP	400 CFM	6.5"	HEPA	2" OR 3"

PNEUMATIC MODELS

ITEM ID	AIR INPUT REQ	AIR FLOW	INCHES OF Hg	FILTRATION	HOSE DIAM
DT55AP	70 CFM @ 65 PSI	110 CFM	12"	STD	1.5" OR 2"
DT55APH	70 CFM @ 65 PSI	110 CFM	12"	HEPA	1.5" OR 2"
DT255AP	140 CFM @ 65 PSI	210 CFM	12"	STD	1.5" OR 2"
DT255APH	140 CFM @ 65 PSI	210 CFM	12"	HEPA	1.5" OR 2"

*1/2" ID AIRLINE REQUIRED

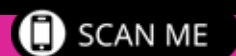



54" BUTTON LOCK WAND

1-1/2" diameter

Part No. – DTA1542

54" BUTTON LOCK WAND

2" diameter

Part No. – DTA2541



54" BUTTON LOCK GULPER WAND

2" diameter

Part No. – DTA2540



60" STRAIGHT WAND/LOCKING EXTENSION

1-1/2" diameter

Part No. – DTA1602



54" STRAIGHT WAND

2" diameter

Part No. – DTA2544

54" FRICTION FIT EXTENSION

2" diameter

Part No. – DTA2542



18" ALUMINUM BULK NOZZLE FOR 1.5" HOSE

Part No. – DTA1441

18" ALUMINUM BULK NOZZLE FOR 2" HOSE

Part No. – DTA2441

18" ALUMINUM BULK NOZZLE FOR 3" HOSE

Part No. - DTA3441



MISCELLANEOUS PARTS



55 GALLON DRUM
Part No. – DTA3001

30 GALLON DRUM
Part No. – DTA3007



55 GALLON DRUM LINER
10 mil
Part No. – DTA3002

30 GALLON POLY BAG
3 mil
Part No. – DTA3006



ACCESSORY RING TOOL HOLDER
Part No. – DT1060

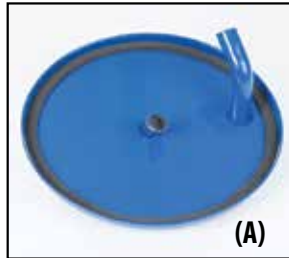

IN-LINE DRUM FILLER
(A) Part No. – DTA3004

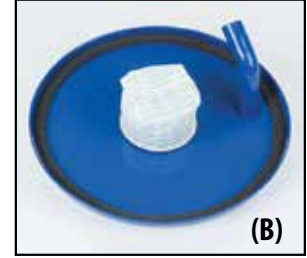

IN-LINE DRUM FILLER w/Filter
(B) Part No. – DTA3004 -F



CYCLONE SEPARATOR
*Custom Models Available
Part No. – DTA3008



IN-LINE DRUM FILLER
w/High Water Shut Off Float
Part No. – DTA3004 -HW

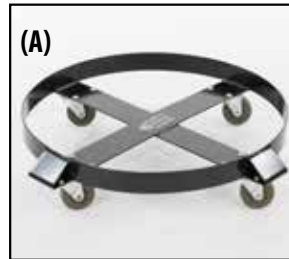

DRUM CADDY
Part No. – DTA3005

DRUM DOLLY
(A) Part No. – DTA3000
DOUBLE DRUM DOLLY
(B) Part No. – DTA3000-D



TILTING DRUM RING
Part No. – DT11032





3" ALUMINUM BRUSH
1-1/2" diameter
Part No. – DTA1030



6" UTILITY NOZZLE
1-1/2" diameter
Part No. – DTA1060



3" ALUMINUM BRUSH COMBO
2" diameter
Part No. – DTH2002/DTA1030



6" UTILITY NOZZLE COMBO
2" diameter
Part No. – DTH2002/DTA1060



3" PLASTIC DUST BRUSH
1-1/2" diameter
Part No. – DTA1031



PLASTIC UTILITY NOZZLE
1-1/2" diameter
Part No. – DTA1319

PLASTIC UTILITY NOZZLE
2" diameter
Part No. – DTA2321



3" PLASTIC DUST BRUSH COMBO
2" diameter
Part No. – DTH2002/DTA1031



24" CHROME CREVICE TOOL
2" diameter

(A) Part No. – DTA2241

15" ALUMINUM CREVICE TOOL

2" diameter

(B) Part No. – DTA2150

11" PLASTIC CREVICE TOOL

1-1/2" diameter

(C) Part No. – DTA1112

11" ALUMINUM CREVICE TOOL

1-1/2" diameter

(D) Part No. – DTA1111



4" CURVED PIPE CLEANING TOOL
1-1/2" diameter
Part No. – DTA1040

6" CURVED PIPE CLEANING TOOL
1-1/2" diameter
Part No. – DTA1061



2" CHROME REDUCER
For 1-1/2" connecting accessories
Part No. – DTH2002



VACTAGON
A DIVISION OF INDUSTRIAL VACUUM



ATTACHMENTS

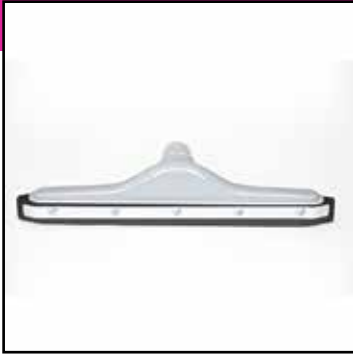

14" SQUEEGEE TOOL
Part No. – DTA1141



14" FLOOR BRUSH
W/nylon bristle
Part No. – DTA1140



18" SQUEEGEE BRUSH & FLOOR BRUSH COMBO
Part No. – DTA1180



20" FLOOR BRUSH WITH NYLON BRISTLE
Part No. – DTA1160



20" SQUEEGEE & BRUSH
2" diameter
Part No. – DTH2006/DTA2201
*Single bend wand required
*Replacement squeegees and brushes available



12" ALUMINUM GULPER TOOL
Part No. – DTA2120



13" GULPER TOOL
2" diameter
Part No. – DTA2130
*Gulper wand required



"Y" ADAPTER
1-1/2" diameter
Part No. – DTH1003

"Y" ADAPTER
2" diameter
Part No. – DTH2003



RUBBER VACUUM HOSE W/O CUFFS
3" diameter
Part No. – DTH3000
RUBBER VACUUM HOSE W/O CUFFS
2" diameter
Part No. – DTH2050
RUBBER VACUUM HOSE W/O CUFFS
1.5" diameter
Part No. – DTH1550

STATIC DISPATCHING HOSE W/ GROUND WIRE
2" diameter (Not Shown)
Part No. – DTH2000

STATIC DISPATCHING HOSE W/ GROUND WIRE
1.5" diameter (Not Shown)
Part No. – DTH1500





2023 PARTS CATALOG TERMS & CONDITIONS OF SALE

This document sets forth the terms and conditions pursuant to which the purchaser ("Purchaser") will purchase and Industrial Vacuum Equipment Corp. ("Seller") will sell the products accessories and attachments (collectively the "Products") ordered by Purchaser. These terms and conditions shall govern and apply to the sale of Seller's Products to Purchaser, regardless of any terms and conditions appearing on any purchase order or other forms submitted by Purchaser to Seller, or the inconsistency of any terms therein and herein.

PAYMENT TERMS

- Net 30 days (to approved and qualified accounts) after the invoice date, regardless of date of receipt of shipment.
- Seller reserves the right to hold shipments against past due accounts.
- All past due accounts are subject to late payment charge of 1.5% per month, or maximum allowed by law if different, along with the expenses incidental to collection including reasonable attorney's fees and costs.
- All prices are in US Dollars.
- Sales Use & Tax may be included to Purchasers invoices, depending on delivery location.
- International shipments that are subject to duties & taxes are the responsibility of the Purchaser.

UPS SHIPMENTS

A handling charge, in accordance with current UPS regulations, will apply to any article that is not fully encased in an outside shipping container. Minimum charge for a package measuring over 84 inches in length and girth combined will be equal to the charge of a package weighing 30 lbs. plus the handling charge. This applies to all UPS air and surface transportation. All Products are shipped UPS standard ground unless otherwise specified by Purchaser.

DELIVERY, DAMAGES, SHORTAGES

Seller shall use reasonable efforts to attempt to cause the Products to be delivered as provided for in these Terms & Conditions. Delivery to the initial common carrier shall constitute the delivery to the Purchaser. Seller's responsibility, insofar as transportation risks are concerned ceases upon the delivery of the Products in good condition to such carrier at the F.O.B. point and all the Products shall be shipped at the purchaser's risk. Seller shall not be responsible or liable for any loss or damage whatsoever, including loss of income and/or profits, or incidental, special, consequential damages resulting from Seller's delayed performance in shipment and delivery.

RETURN OF DEFECTIVE PRODUCTS

Defective or failed material shall be held at the Purchaser's premises until authorization has been granted by Seller to return or dispose of Products. Seller must be notified within 30 days of receipt of defective Product. Products that are to be returned for final inspection must be returned Freight Prepaid in the most economical way. Credit will be issued for material found to be defective upon Seller's inspection based on prices at time of purchase.

- No returns of Products will be accepted without prior authorization from Seller.
- All returns require a Return Material Authorization (RMA) number provided by Seller.

PRODUCTS ORDERED IN ERROR

Standard package Products only may be returned, provided that claim is made and Seller is notified within 7 days of receipt of Products, and the Products are in the original buyer's possession not more than 30 days prior to return, subject to Seller's approval. If Products are accepted for return they must be Freight Prepaid, and buyer will be charged a minimum of 15% rehandling charge, plus a chargeback for outbound freight charges if the original order was shipped prepaid. Returns are not accepted for any Products that are specially manufactured to meet the buyer's requirement of either specifications or large quantity.

PRODUCTS SHIPPED IN ERROR

Purchaser must notify within 7 days of receipt of Product any Products shipped in error. Upon notification, Products are to be returned to Seller either via truck on a Freight Collect basis, or via UPS on a Freight Prepaid basis. Purchaser will be reimbursed for cost of Products, plus any additional freight which may have been incurred due to shipping error.

- No returns of Products will be accepted without prior authorization from Seller.
- All returns require a Return Material Authorization (RMA) number provided by Seller.

INDUSTRIAL VACUUM EQUIPMENT CORPORATION
N8150 Maple Street • Ixonia, WI 53036
P: 920.261.1136 • F: 920.261.7117
E: info@industrialvacuum.com • Toll Free:
800.331.4832 www.industrialvacuum.com



N8150 Maple Street • Ixonia, WI 53036

P: 920.261.1136 • F: 920.261.7117

Toll Free: 800.331.4832

www.industrialvacuum.com